



# Operator's Manual

## T-1090 SPECTRUM

Multi-Temperature Unit with Premium HMI

Revision B

# Introduction

This manual is published for informational purposes only and the information furnished herein should not be considered as all-inclusive or meant to cover all contingencies. If more information is required, consult your Thermo King Service Directory for the location and telephone number of the local dealer.

**Thermo King's warranty shall not apply to any equipment which has been "so installed, maintained, repaired or altered as, in the manufacturer's judgment, to affect its integrity."**

***Manufacturer shall have no liability to any person or entity for any personal injury, property damage or any other direct, indirect, special, or consequential damages whatsoever, arising out of the use of this manual or any information, recommendations or descriptions contained herein. The procedures described herein should only be undertaken by suitably qualified personnel. Failure to implement these procedures correctly may cause damage to the Thermo King unit or other property or personal injury.***

There is nothing complicated about operating and maintaining your Thermo King unit, but a few minutes studying this manual will be time well spent.

Performing pre-trip checks and enroute inspections on a regular basis will minimize operating problems. A regular maintenance program will also help to keep your unit in top operating condition. If factory recommended procedures are followed, you will find that you have purchased the most efficient and dependable temperature control system available.

All service requirements, major and minor, should be handled by a Thermo King dealer for four very important reasons:

- They are equipped with the factory recommended tools to perform all service functions.
- They have factory trained and certified technicians.
- They have genuine Thermo King replacement parts.
- The warranty on your new unit is valid only when the repair and replacement of component parts is performed by an authorized Thermo King dealer.

## Customer Satisfaction Survey

Let your voice be heard!

Your feedback will help improve our manuals. The survey is accessible through any internet-connected device with a web browser.

Scan the Quick Response (QR) code or click [Technical Publications TK Americas Feedback](#) to complete the survey.



# Table of Contents

<b>Safety Precautions</b> .....	<b>8</b>
Danger, Warning, Caution, and Notice .....	8
General Practices .....	8
Automatic Start/Stop Operation .....	10
Electrical Hazard .....	10
Low Voltage .....	11
Refrigeration System Hazards .....	12
Refrigerant Oil Hazards .....	13
First Aid .....	13
Welding Precautions .....	15
Safety Nameplates .....	16
<b>Unit Description</b> .....	<b>17</b>
General Description .....	17
Design Features .....	18
Unit Options .....	19
Engine .....	20
ELC (Extended Life Coolant) .....	20
Clutch .....	21
Reciprocating Compressor .....	21
HMI Controller .....	21
CYCLE-SENTRY™ Start/Stop System .....	21
Defrost .....	21
TrackKing™ .....	22
SmartPower Electric Standby (Model 50 Units Only) .....	23
SmartPower Standard Features .....	23
SmartPower Optional Features .....	23

Unit Protection Devices .....	23
Engine Compartment Components.....	24
Unit Components.....	25

**Operating Instructions for Premium HMI Control Panel.....28**

Truck Premium Display HMI Control Panel .....	28
Display .....	28
Hard Keys .....	29
Soft Keys .....	30
Turning the Unit On and Off.....	31
If More Than One Language is Enabled.....	32
The Standard Display.....	35
Changing the Setpoint.....	36
Starting the Diesel Engine .....	38
Starting the Electric Motor .....	39
Switching from Diesel to Electric .....	40
Switching from Electric to Diesel .....	41
Initiating a Manual Defrost Cycle .....	43
Terminating a Defrost Cycle .....	44
Selecting High Speed Lockout Mode (If Enabled) .....	44
Using the Gauges Key .....	46
Gauges Available .....	47
Using the Sensors Key .....	48
Sensors Available .....	49
Using The Main Menu .....	50
Main Menu Choices.....	50
Languages Menu .....	52
Alarms .....	55
Log Alarms .....	55
Check Alarms .....	56
Shutdown Alarms .....	56
Prevent Alarms.....	56

## Table of Contents

---

Pretrip Alarm Codes . . . . .	57
Alarm Codes When Switching Between Diesel and Electric . . . . .	57
Alarm Code Notification . . . . .	58
Clearing Alarm Codes . . . . .	58
Displaying and Clearing Alarm Codes . . . . .	59
Table of Alarm Codes . . . . .	62
Datalogger Menu . . . . .	65
Hourmeters Menu . . . . .	67
Hourmeter Names and Definitions . . . . .	68
Mode Menu . . . . .	69
Selecting CYCLE-SENTRY or Continuous Mode . . . . .	72
Selecting Temperature Display Units . . . . .	74
Keypad Lockout . . . . .	76
Selecting Sleep Mode . . . . .	78
Pretrip . . . . .	83
Pretrip Test Conditions . . . . .	83
Conditions where Pretrip Tests are Not Allowed . . . . .	83
Pretrip Test Sequence . . . . .	84
Pretrip Test Considerations . . . . .	84
Performing a Pretrip Test . . . . .	85
Diesel/Electric Menu . . . . .	88
Adjust Brightness Menu . . . . .	88
Time Menu . . . . .	90
<b>Loading and Enroute Inspections . . . . .</b>	<b>92</b>
Inspecting the Load . . . . .	92
Enroute Inspections . . . . .	93
<b>Specifications . . . . .</b>	<b>95</b>
Engine Specifications . . . . .	95
Refrigeration System . . . . .	96
Electrical Control System Specifications . . . . .	96

Fuses .....	96
Electric Standby Specifications (SmartPower™ Model 50 Units) .....	97
Electric Motor and Overload Relay .....	97
Standby Power Requirements .....	98
<b>Unit Maintenance .....</b>	<b>99</b>
Maintenance Inspection Schedule .....	100
Remote Evaporators .....	100
<b>Serial Number Locations .....</b>	<b>101</b>
<b>Emergency Cold Line .....</b>	<b>104</b>
<b>Unit Warranty .....</b>	<b>105</b>
EPA and ARB Supplemental Emissions Warranty Statement .....	105

# Safety Precautions

## Danger, Warning, Caution, and Notice

Thermo King® recommends that all service be performed by a Thermo King dealer and to be aware of several general safety practices.

Safety advisories appear throughout this manual as required. Your personal safety and the proper operation of this unit depend upon the strict observance of these precautions. The four types of advisories are defined as follows:

### **▲ DANGER**

#### **Hazard!**

Indicates an imminently hazardous situation which, if not avoided, will result in death or serious injury.

### **▲ WARNING**

#### **Hazard!**

Indicates a potentially hazardous situation which, if not avoided, could result in death or serious injury.

### **▲ CAUTION**

#### **Hazard!**

Indicates a potentially hazardous situation which, if not avoided, could result in minor or moderate injury and unsafe practices.

### **NOTICE**

#### **Hazard!**

Indicates a situation that could result in equipment or property-damage only accidents.

## General Practices

### **▲ DANGER**

#### **Risk of Injury!**

Improper servicing can lead to fire, electrocution, or explosion. Never service, repair, or troubleshoot a system unless you are a professional service person.



**⚠ DANGER**

**Hazardous Gases - Personal Protective Equipment (PPE) Required!**

Refrigerant in the presence of an open flame, spark, or electrical short produces toxic gases that are severe respiratory irritants which can cause serious injury or possible death. When working with or around hazardous chemicals, ALWAYS refer to appropriate Material Data Safety Sheets (MSDS) and OSHA/GHS (Global Harmonized System of Classification and Labelling of Chemicals) guidelines for information on allowable personal exposure levels, proper respiratory protection, and handling instructions.

**⚠ DANGER**

**Confined Space Hazards!**

Avoid engine operation in confined spaces and areas or circumstances where fumes from the engine could become trapped and cause serious injury or death.

**⚠ WARNING**

**Risk of Injury!**

When using ladders to install or service refrigeration systems, always observe the ladder manufacturer's safety labels and warnings. A work platform or scaffolding is the recommended method for installations and servicing.

**⚠ WARNING**

**Risk of Injury!**

Never operate the unit unless you completely understand the controls; otherwise serious injury may occur.

**⚠ CAUTION**

**Service Procedures!**

Turn the unit off before attempting to check the engine oil.

**⚠ CAUTION**

**Hazardous Pressures!**

Do not remove expansion tank cap while coolant is hot.

## Safety Precautions

### **⚠ CAUTION**

#### **Risk of Injury!**

Avoid direct contact with hot coolant.

## Automatic Start/Stop Operation

### **⚠ CAUTION**

#### **Risk of Injury!**

The unit can start and run automatically any time the unit is turned on. Units start automatically in both Cycle Sentry mode and Continuous mode. Turn the unit On/Off switch Off and disconnect the battery before doing inspections or working on any part of the unit.

### **⚠ CAUTION**

#### **Risk of Injury!**

Thermo King units may have options that allow for remote starting from a fully off state. Turn the unit On/Off switch Off and disconnect the battery before doing inspections or working on any part of the unit.

## Electrical Hazard

### **⚠ DANGER**

#### **Hazardous Voltage!**

When servicing or repairing a temperature control unit, the possibility of serious or even fatal injury from electrical shock exists. Extreme care must be used when working with a refrigeration unit that is connected to a source of operating power, even if the unit is not operating. Lethal voltage potentials can exist at the unit power cord, inside the control box, at the motors and within the wiring harnesses.

### **⚠ WARNING**

#### **Risk of Injury!**

On SmartPower electric standby equipped units, always turn off the external standby power source before handling, connecting, or disconnecting the power cable. Always disconnect the standby power cord before servicing the unit.

**⚠ WARNING**

**Hazardous Voltage!**

The unit On/Off switch must be turned Off before connecting or disconnecting the standby power plug. Never attempt to stop the unit by disconnecting the power plug.

**⚠ WARNING**

**Risk of Injury!**

The unit power plug must be clean and dry before connecting it to a power source.

**⚠ WARNING**

**Hazardous Voltage!**

A certified electrician should verify that the proper standby power requirements are being supplied before connecting to a new power source.

**Low Voltage**

**Important:** *Some SR-3 components are connected directly to un-switched battery power. All connections and circuits labeled with a "2" prefix are connected directly to battery power. Always disconnect the battery before servicing the unit.*

**⚠ WARNING**

**Live Electrical Components!**

Control circuits used in refrigeration units are low voltage (12 to 48 Vdc). However, the large amount of amperage available can cause severe burns if accidentally shorted to ground with metal objects, such as tools. Do not wear jewelry, watches, or rings because they increase the risk of shorting out electrical circuits and damaging equipment or causing severe burns. If there is a risk of energized electrical contact, arc, or flash, technicians **MUST** put on all PPE in accordance with OSHA, NFPA 70E, or other local, state, or country-specific requirements for arc flash protection **PRIOR** to servicing the unit. **NEVER PERFORM ANY SWITCHING, DISCONNECTING, OR VOLTAGE TESTING WITHOUT PROPER ELECTRICAL PPE AND ARC FLASHING CLOTHING. ELECTRICAL METERS AND EQUIPMENT MUST BE PROPERLY RATED FOR INTENDED VOLTAGE.**

---

## Refrigeration System Hazards

In the United States all technicians who maintain, service, repair, or dispose of equipment that could release refrigerants into the atmosphere must be EPA 608 certified. Thermo King recommends all service be performed by a Thermo King dealer.

### **⚠ DANGER**

#### **Hazardous Gases - Personal Protective Equipment (PPE) Required!**

Refrigerant in the presence of an open flame, spark, or electrical short produces toxic gases that are severe respiratory irritants which can cause serious injury or possible death. When working with or around hazardous chemicals, ALWAYS refer to appropriate Material Data Safety Sheets (MSDS) and OSHA/GHS (Global Harmonized System of Classification and Labelling of Chemicals) guidelines for information on allowable personal exposure levels, proper respiratory protection, and handling instructions.

### **⚠ DANGER**

#### **Refrigerant Vapor Hazard!**

Do not inhale refrigerant. Use caution when working with refrigerant or a refrigeration system in any confined area with a limited air supply. Refrigerant displaces air and can cause oxygen depletion, resulting in suffocation and possible death. When working with or around hazardous chemicals, ALWAYS refer to appropriate Material Data Safety Sheets (MSDS) and OSHA/GHS (Global Harmonized System of Classification and Labelling of Chemicals) guidelines for information on allowable personal exposure levels, proper respiratory protection, and handling instructions.

### **⚠ WARNING**

#### **Personal Protective Equipment (PPE) Required!**

Refrigerant in a liquid state evaporates rapidly when exposed to the atmosphere, freezing anything it contacts. Wear butyl lined gloves and other clothing and eye wear when handling refrigerant to help prevent frostbite. When working with or around hazardous chemicals, ALWAYS refer to appropriate Material Data Safety Sheets (MSDS) and OSHA/GHS (Global Harmonized System of Classification and Labelling of Chemicals) guidelines for information on allowable personal exposure levels, proper respiratory protection, and handling instructions.

## Refrigerant Oil Hazards

### **WARNING**

#### **Personal Protective Equipment (PPE) Required!**

Protect your eyes from contact with refrigerant oil. The oil can cause serious eye injuries. Protect skin and clothing from prolonged or repeated contact with refrigerant oil. To prevent irritation, wash your hands and clothing thoroughly after handling the oil. Rubber gloves are recommended. When working with or around hazardous chemicals, ALWAYS refer to appropriate Material Data Safety Sheets (MSDS) and OSHA/GHS (Global Harmonized System of Classification and Labelling of Chemicals) guidelines for information on allowable personal exposure levels, proper respiratory protection, and handling instructions.

### **NOTICE**

#### **Material Damage!**

Wipe up spills immediately. Refrigerant oil can damage paints and rubber materials.

## First Aid

### REFRIGERANT

- **Eyes:** For contact with liquid, immediately flush eyes with large amounts of water and get prompt medical attention.
- **Skin:** Flush area with large amounts of warm water. Do not apply heat. Remove contaminated clothing and shoes. Wrap burns with dry, sterile, bulky dressing to protect from infection. Get prompt medical attention. Wash contaminated clothing before reuse.
- **Inhalation:** Move victim to fresh air and use Cardio Pulmonary Resuscitation (CPR) or mouth-to-mouth resuscitation to restore breathing, if necessary. Stay with victim until emergency personnel arrive.
- **Frost Bite:** In the event of frost bite, the objectives of First Aid are to protect the frozen area from further injury, warm the affected area rapidly, and to maintain respiration.

### REFRIGERANT OIL

- **Eyes:** Immediately flush with large amounts of water for at least 15 minutes. Get prompt medical attention.

## Safety Precautions

---

- **Skin:** Remove contaminated clothing. Wash thoroughly with soap and water. Get medical attention if irritation persists.
- **Inhalation:** Move victim to fresh air and use Cardio Pulmonary Resuscitation (CPR) or mouth-to-mouth resuscitation to restore breathing, if necessary. Stay with victim until emergency personnel arrive.
- **Ingestion:** Do not induce vomiting. Immediately contact local poison control center or physician.

### ENGINE COOLANT

- **Eyes:** Immediately flush with large amounts of water for at least 15 minutes. Get prompt medical attention.
- **Skin:** Remove contaminated clothing. Wash thoroughly with soap and water. Get medical attention if irritation persists.
- **Ingestion:** Do not induce vomiting. Immediately contact local poison control center or physician.

### BATTERY ACID

- **Eyes:** Immediately flush with large amounts of water for at least 15 minutes. Get prompt medical attention. Wash skin with soap and water.
- **Skin:** Immediately remove contaminated clothing. Wash skin with large volumes of water, for at least 15 minutes. Wash skin with soap and water. Do not apply fatty compounds. Seek immediate medical assistance.
- **Inhalation:** Provide fresh air. Rinse mouth and nose with water. Seek immediate medical assistance.
- **Ingestion:** If the injured person is fully conscious: make the person drink extensive amounts of milk. Do not induce vomiting. Take the injured person immediately to a hospital.

### ELECTRICAL SHOCK

Take IMMEDIATE action after a person has received an electrical shock. Get quick medical assistance, if possible.

The source of the shock must be quickly stopped, by either shutting off the power or removing the victim. If the power cannot be shut off, the wire should be cut with a non-conductive tool, such as a wood-handle axe or thickly insulated cable cutters. Rescuers should wear insulated gloves and safety glasses, and avoid looking at wires being cut. The ensuing flash can cause burns and blindness.

If the victim must be removed from a live circuit, pull the victim away with a non-conductive material. Use wood, rope, a belt or coat to pull or push the victim away from the current. **DO NOT TOUCH** the victim. You will receive a shock from current flowing through the victim's body. After separating the victim from power source, immediately check for signs of a pulse and respiration. If no pulse is present, start Cardio Pulmonary Resuscitation (CPR). If a pulse is present, respiration might be restored by using mouth-to-mouth resuscitation. Call for emergency medical assistance.

### **ASPHYXIATION**

Move victim to fresh air and use Cardio Pulmonary Resuscitation (CPR) or mouth-to-mouth resuscitation to restore breathing, if necessary. Stay with victim until emergency personnel arrive.

## **Welding Precautions**

Take precautions before electrically welding any portion of the unit or the vehicle to which it is attached. Verify that welding currents are not allowed to flow through the unit's electronic circuits.

Observe the following precautions when welding to avoid damaging electronic components.

- If the microprocessor has a power switch, turn it OFF before connecting or disconnecting the battery.
- Disconnect power to the unit.
- Disconnect all wire harnesses from the microprocessor.
- If there are any electrical circuit breakers in the control box, switch them OFF.
- Close the control box.
- Components that could be damaged by welding sparks should be removed from the unit.
- Use normal welding procedures, but keep the ground return electrode as close to the area being welded as practical. This will reduce the likelihood of stray welding currents passing through any electronic circuits.

## Safety Nameplates

Observe all safety nameplates placed in various locations on the unit.

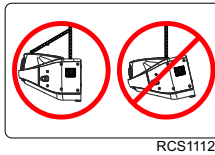
**Figure 1. Proposition 65 Nameplate**



**Figure 2. Automatic Start Warning Nameplate**



**Figure 3. Caution Lifting Nameplate**



**Figure 4. Caution No Grab No Step Nameplate**



**Figure 5. High Voltage Nameplate**





# Unit Description

## General Description

The T-1090 SPECTRUM™ is a self-powered multi-temperature cooling and heating unit designed for straight trucks. The condensing unit is mounted on the front of the truck cargo box. The remote evaporators are located in up to three individual compartments inside the cargo box. The unit uses Chlorine free R-404A refrigerant.

The basic models provide the following:

**Standard Unit (Model 30):** Cooling and hot gas heating on engine operation.

**SmartPower™ Unit (Model 50):** Cooling and hot gas heating on engine operation and electric standby operation.

A three cylinder, EPA Tier 4, special clean and quiet diesel engine powers the unit when in the truck is in route. SmartPower (Model 50) units are also equipped with an electric motor for standby power operation while the truck is stationary.

The SR-3 microprocessor based temperature control system and in-cab HMI controller manage unit functions. CYCLE-SENTRY™, an exclusive Thermo King feature, automatically starts and stops the unit according to temperature demands. This continuous monitoring function optimizing the unit's performance and reduces fuel consumption while maintaining temperature in multiple compartments.

The on-board Pretrip unit self check feature can be run before beginning the daily distribution route to identify any possible unit malfunctions and help prevent down time.

## **Design Features**

- Microprocessor Controlled
- Continuous System Monitoring
- In-Cab HMI Controller
- Alarm Code Display
- Battery Voltage Display
- Coolant Temperature Display
- CYCLE-SENTRY Start/Stop Controls
- Engine and Electric SmartPower (Model 50) Hour Meter
- OptiSet Plus Temperature Profiles
- Smart Defrost
- Unit Self Check-pretripping
- Aerodynamic Thermo Plastic Injection Molded Skins with In-mold Color
- Air Cleaner, Dry Type
- Alternator, 12 Volt, 37 Amp
- Bypass Oil Filter (if equipped, see SB803)
- Coolant Expansion Tank
- Economy Mode
- Fahrenheit and Celsius Display
- Fuel Filter, Spin On
- Oil Filter, Full Flow
- Serpentine Belt with Manual Tensioner
- R-404A Chlorine-free Refrigerant
- Robotic Welded Steel Frame
- X214 Compressor (T-590 and T-690)
- X430P Compressor (T890, T-1090 and T-1090 SPECTRUM)
- ETV (Electronic Throttling Valve) (T-690, T-890, T-1090 and T-1090 SPECTRUM)
- TK374F Tier 4 Diesel Engine (T-590, T-690, and T-890)
- TK380F Tier 4 Diesel Engine (T-1090 and T-1090 SPECTRUM)
- USB Diagnostic Port
- TrackKing™

## Unit Options

- Body Mount HMI Enclosure
- Door Switch
- MAX Cooling System
- Electric Evaporator Heaters
- SmartPower Electric Standby (Model 50)
- SmartPower Automatic Phase Correction (Model 50)
- SmartPower Diesel/Electric Autoswitching (Model 50)
- Engine Block Heater
- Fuel Tank (30 gallon aluminum, 18" and 22")
- Quick Oil Drain Kit
- Rear Remote Control (flushmount)
- Remote Indicator Light
- Snow Cover
- Whisper™ Sound Kit
- Top Cover System
- Precision Temperature Control (except T-590 / 690)
- TouchLog
- Bluetooth
- Solar Panels
- Battery Box
- Evaporator Side Screens

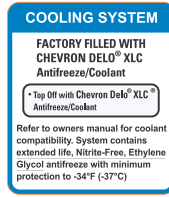
## Engine

Engine power for the T-1090 SPECTRUM is provided by the TK380F, a three cylinder, EPA Tier 4, special clean and quiet diesel engine rated at 19.3 continuous horsepower (14.4 kW) at 2425 RPM. A belt drive system transfers energy to the compressor and alternator.

## ELC (Extended Life Coolant)

The maintenance interval for ELC is eight years or 15,000 hours. A nameplate near the coolant expansion tank identifies units with ELC. This coolant is Red instead of the previous Green or Blue-Green coolants.

**Figure 6. ELC (Extended Life Coolant) Nameplate**



**Important:** Only OAT extended life coolants (Chevron Delo® XLC or equivalent) should be added to Thermo King systems. Conventional coolants should not be used (Typically identified by green or blue-green color). If a conventional coolant is combined with the Thermo King factory fill up to 25% by volume, the coolant must be changed at the next service opportunity. Above 25%, the coolant must be changed immediately. Conventional coolants dilute/interact with the additive packages of extended life coolant which significantly reduces the service life of the coolant.

**Note:** The use of 50/50% pre-mixed ELC is recommended to ensure that deionized water is being used. If 100% full strength concentrate is used, deionized or distilled water is recommended instead of tap water to ensure the integrity of the cooling system is maintained. The engine must have antifreeze protection to -40°F/ -40°C. Check and add coolant in the expansion tank as needed.

---

## Clutch

The centrifugal clutch engages fully at  $600 \pm 100$  RPM on engine operation, constantly turning the compressor, alternator, and fans at both high and low speed. The clutch isolates the engine from the belt drive system during electric standby operation on Model 50 units.

## Reciprocating Compressor

The T-1090 SPECTRUM features the X430P, 4 cylinder reciprocating compressor with 30.0 cu in (492 cc) displacement.

## HMI Controller

The HMI Controller communicates with the Base Controller (located inside the control box) and is used to operate the unit and display unit information. It also provides access to all the controller functions and menus.

## CYCLE-SENTRY™ Start/Stop System

The CYCLE-SENTRY Start/Stop fuel saving system provides optimum operating economy.

### **WARNING**

#### **Risk of Injury!**

The unit can start at any time without warning. Press the OFF key on the HMI control panel, place the unit Service Switch (On/Off switch) in the Off position, and disconnect the battery before inspecting or servicing any part of the unit.

The CYCLE-SENTRY system automatically starts the unit on microprocessor demand and shuts down the unit when all demands are satisfied.

The system monitors and maintains the compartment temperature, the engine block temperature, and battery charge levels at a point where quick, easy starts are possible.

## Defrost

Frost will gradually build up on the evaporator coils as a result of normal operation. Periodically this frost must be melted to prevent a loss of cooling and airflow.

## Unit Description

---

Defrost is accomplished by passing hot refrigerant gas through the evaporator coil, thus melting the frost (or ice). Melted frost drains out of the unit onto the ground through the drain tubes.

Defrost can be initiated at any time the evaporator coil temperature is below 42 F (5.5 C).

There are two methods of defrost initiation:

**SR-2/SR-3 Microprocessor Controller:** The Microprocessor Controller is programmed to automatically initiate timed and forced defrost cycles. The SR-2/SR-3 uses temperature sensors to determine if forced defrost is required.

**Manual Defrost:** Manual Defrost allows the operator to initiate a defrost cycle by pressing the Defrost key. See "Initiating a Manual Defrost Cycle."

## TrackKing™

T-90 series units are equipped with a wireless communication platform that offers fleet owners the ability to monitor their refrigerated units. Cellular, GPS, and Bluetooth capabilities communicate with Thermo King's web-based TrackKing™ application, and Bluetooth with the Thermo King Reefer App. A third party interface offers a gateway for telematics providers to communicate with the Thermo King unit. To learn more about the TrackKing features, contact your Thermo King dealer.

TrackKing Components:

- **TKV5 Module** — is located inside the controls section of the unit. The telematics module with built-in antenna allows for wireless communication with the e1000 unit. No service is required by the operator.
- **AGM battery** — is located inside the condenser section under the cooling system expansion tank. This battery is used to power the telematics system when in unit is turned off. The battery is charged when the unit is operating. and No service is required by the operator.
- **110W Solar Panel** — typically located on cargo box roof. The solar panel keeps the AGM battery charged when the unit is not in use. No service is required by the operator other then keeping the panel free of any dirt of debris.

---

## SmartPower Electric Standby (Model 50 Units Only)

The SmartPower Electric Standby option allows the unit to be operated on either the diesel engine or external electric power.

### **DANGER**

#### **Hazardous Voltage!**

High voltage AC power is present whenever the unit is operating in the Electric Standby mode and whenever the unit is connected to external standby power. Voltages of this magnitude can be lethal. Exercise extreme caution when working on the unit.

## SmartPower Standard Features

The following features are standard equipment on units equipped with SmartPower Electric Standby.

**Automatic Diesel/Electric Selection:** The unit will automatically switch to electric operation when a power cord is connected and the standby power is switched On.

**Overload Relay:** The overload relay is self-resetting.

**Hot Gas Heat:** Hot gas heat is utilized on all units.

**Automatic Phase Correction:** The control system features two motor contactors. This allows correct motor rotation regardless of phase rotation on the incoming power.

## SmartPower Optional Features

The following features are available as options on units equipped with Electric Standby.

- Auto Switching

## Unit Protection Devices

**High Pressure Cutout Switch (HPCO):** This normally closed switch monitors the discharge pressure at the compressor. It opens on high discharge pressure to shut the unit down to prevent damage.

**Electronic Throttling Valve (ETV):** This component is an electromechanical control device used to limit the suction pressure to the compressor. The valve is controlled by the microprocessor controller.

## Unit Description

---

**Preheat Buzzer:** The preheat buzzer sounds when the CYCLE-SENTRY system energizes the glow plugs. This should warn anyone near the unit that the CYCLE-SENTRY system is about to start the diesel engine.

**Coolant Temperature Sensor:** This sensor provides an engine coolant temperature input to the microprocessor. If the engine coolant temperature is too high, the controller stops the unit and records an alarm.

**Electric Motor Overload Relay (Model 50):** The overload relay protects the electric standby motor. The overload relay opens the circuit from the contactor to the electric motor if the motor overloads for any reason and an alarm will occur. The relay resets when the alarm code is cleared.

**Fuses:** Sizes and functions are described in the Specifications chapter of this manual.

## Engine Compartment Components

**Coolant Expansion Tank:** The coolant level and temperature are monitored by the base controller. If the coolant temperature becomes too high or the level becomes too low, an alarm will occur.

### CAUTION

#### **Hazardous Pressures!**

Do not remove expansion tank cap while coolant is hot.

**Engine Oil Dipstick:** Use the engine oil dipstick to check the engine oil level.

**Receiver Tank Sight Glass:** The receiver tank sight glass is used to assist in checking the amount of refrigerant in the system.

**Compressor Oil Sight Glass:** The compressor oil sight glass is used to check the relative level of compressor oil in the compressor sump.



---

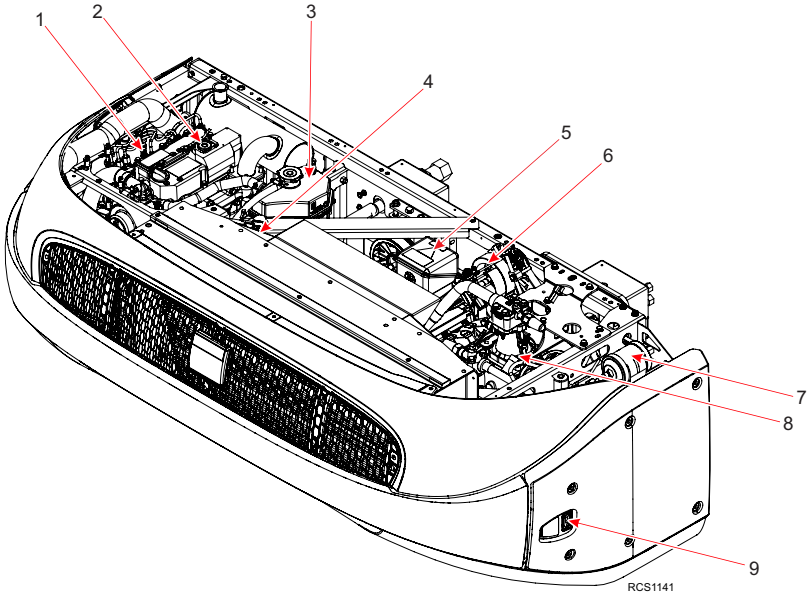
## Unit Components

Figure 7. Front View of Unit



RCS1207

**Figure 8. Engine Compartment Components**



1.	Engine Oil Dipstick (on side of engine)	6.	Alternator
2.	Engine	7.	Dehydrator (Filter-Drier)
3.	Coolant Expansion Tank	8.	Compressor
4.	Coolant Overflow Bottle	9.	Base Controller On/Off Switch
5.	Electric Motor		

**Figure 9. S-2 Remote Evaporator – Front View**



**Figure 10. S-3 Remote Evaporator – Front View**

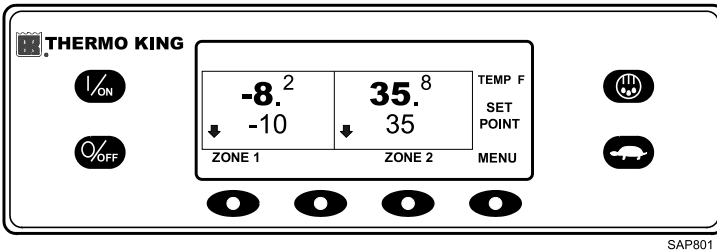


# Operating Instructions for Premium HMI Control Panel

## Truck Premium Display HMI Control Panel

The Truck Premium Display is used to operate the unit, display unit information, and access all Maintenance and Guarded Access Menus. The Truck Premium Display communicates with the Base Controller via the Controller Area Network (CAN) bus. It is connected to the Base Controller via CAN Connector J14 on the interface board. The Truck Premium Display is typically located in the vehicle driver’s compartment. It may be installed in the truck instrument panel using a DIN mounting ring or under the instrument panel using an under dash mounting kit.

**Figure 11. Truck Premium HMI Control Panel**



The HMI control panel consists of a display and 8 touch-sensitive keys.

The display is capable of showing both text and graphics.

The keys on the left and right sides of the display are dedicated single function “hard” keys.

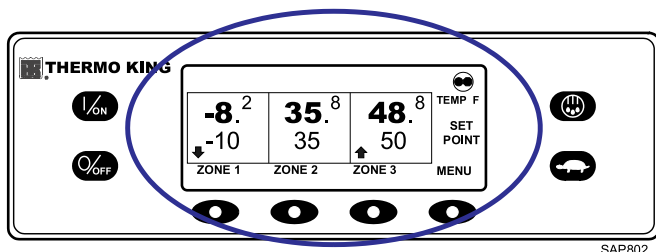
The four keys under the display are “soft” keys. The functions of these soft keys change depending on the operation being performed. If a soft key is active the current key function is shown in the display directly above the key.

## Display

The display presents information to the operator. This information includes setpoint and temperature for each zone, unit or zone operating information, gauge readings, temperatures, and other information as selected by the operator.

## Operating Instructions for Premium HMI Control Panel

**Figure 12. Display**



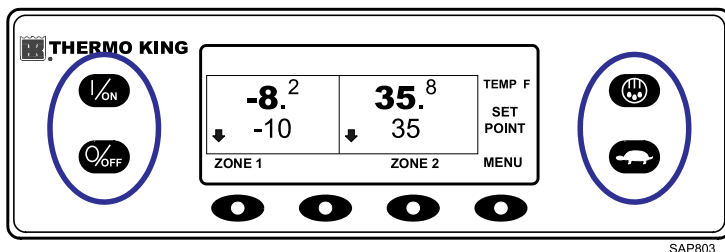
The Standard Display of box temperature and setpoint for three zones is shown (Figure 12, p. 29). The Cycle Sentry Icon in the upper right of the display shows the unit is running in Cycle Sentry Mode. Zone 1 has a setpoint of -10°F, and a return air temperature of -8.2°F. The downward pointing arrow shows this zone is cooling. Zone 2 has a setpoint of 35°F, and a return air temperature of 35.8°F. The absence of an arrow indicates that this zone is in null. Zone 3 has a setpoint of 50°F, and a return air temperature of 48.8°F. The upward pointing arrow shows this zone is heating.

**Note:** The zone temperature shown is always return air temperature.

The four keys under the display are termed “soft” keys. The functions of these keys change depending on the operation being performed. The function of each soft key is shown by labels in the display located directly above each soft key. The soft key under each zone is used to turn that zone on and off and allows the Setpoint for that zone to be changed. Pressing the soft key under MENU accesses the MAIN MENU.

## Hard Keys

**Figure 13. Hard Keys**



## Operating Instructions for Premium HMI Control Panel

The keys on either side of the display are dedicated or "hard" keys. Their function always remains the same.



This key is used to turn the unit on. First the display will briefly show the Thermo King Logo and then the statement "Configuring System - Please Wait". When the power-up sequence is complete the display shows the Standard Display of box temperature and setpoint. For more information see "Turning the Unit On and Off" later in this section.



This key is used to turn the unit off. First the display will briefly show "System is Powering Down - Please Wait. Press On to Resume" and then "Off" will appear momentarily. When the power-down sequence is complete the display will be blank. For more information see "Turning the Unit On and Off" later in this section.



This key is used to initiate a manual defrost cycle. For more information see "Initiating a Manual Defrost Cycle" later in this section.

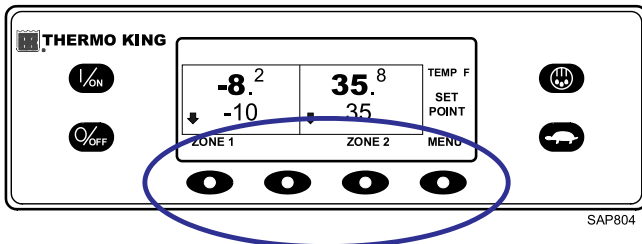


This key is used to lock out high speed operation in noise sensitive areas. For more information see "Selecting High Speed Lockout" later in this section.

**Note:** The Thermo King Premium Truck HMI Control Panel features a High Speed Lock-Out key as shown here. The Thermo King Truck HMI Control Panel features a Cycle Sentry key in this position. When using the Thermo King Premium Truck HMI Control Panel, Cycle Sentry Mode or Continuous Mode is selected from the Main Menu - Mode Submenu as shown later in this section.

## Soft Keys

Figure 14. Soft Keys



The four "soft" keys under the display are multi-purpose keys. Their function changes depending on the operation being performed. If a soft key is active the key function is shown in the display directly above the key. The keys are numbered from left to right, with Key 1 on the far left and Key 4 on the far right.

## Operating Instructions for Premium HMI Control Panel

Typical soft key functions:

ZONE ON/OFF and SETPOINT CHANGE

MENU	+ or -	HOURLMETERS	EXIT
NEXT	SELECT	GAUGES	HELP
YES/NO	CLEAR	BACK	SENSORS

### Turning the Unit On and Off

**Important:** Verify the Base Controller On/Off Switch is turned on before turning on the HMI Control Panel. The Base Controller On/Off switch is located on the outside of the control box side of the unit.

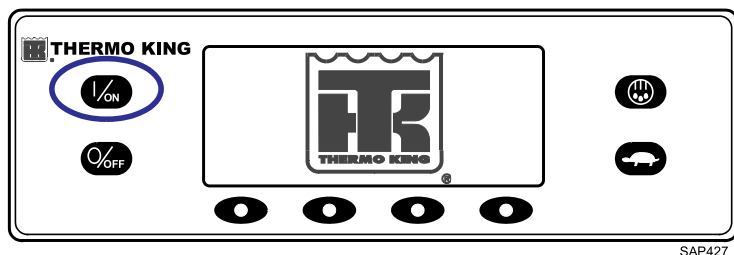
If the HMI Control Panel is turned on and the Base Controller On/Off Switch is turned off, the HMI display screen will briefly show LOST CONTROLLER POWER. The HMI will then power down.

The unit is turned on by pressing the ON key and off by pressing the OFF key. When the ON key is pressed, the display briefly shows the THERMO KING Logo as the display initializes.

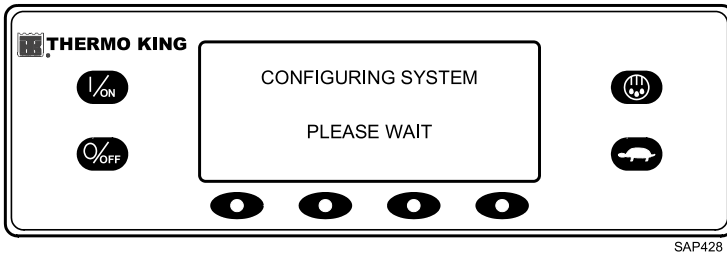
**Important:** The ON key must be held down until the Thermo King Logo appears as shown (Figure 15, p. 31). If the ON key is not held down long enough (approximately ½ second), the display may flicker but the unit will not start up. If this occurs, hold the ON key down until the Thermo King logo appears.

**Note:** With extremely cold ambient temperatures, it may take up to 15 seconds for the display to appear on initial startup.

Figure 15. ON Key

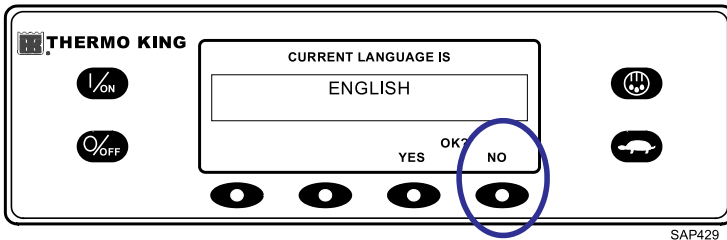


The startup screen shown (Figure 16, p. 32) appears while communications are established and the unit prepares for operation.

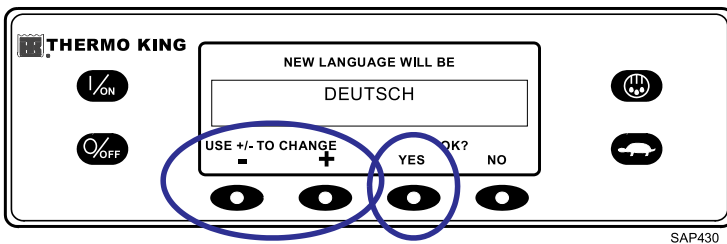
**Figure 16. Startup Screen**

### If More Than One Language is Enabled

If more than one language has been enabled, a prompt will appear to allow the desired language to be chosen as shown (Figure 17, p. 32). Only languages enabled from the Guarded Access Menu are available. If a different language is desired, press the NO key.

**Figure 17. NO key**

The Language menu will appear as shown (Figure 18, p. 32). Press the + or - keys to select the desired language. When the desired language is shown, press the YES key to confirm the choice.

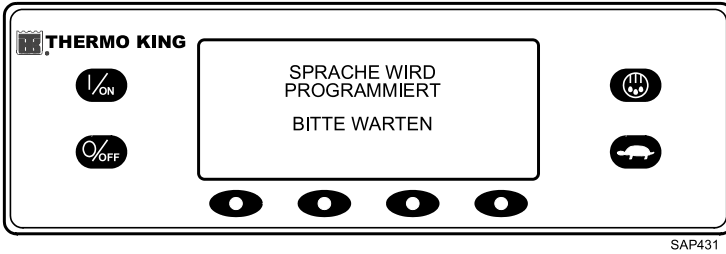
**Figure 18. YES Key**



## Operating Instructions for Premium HMI Control Panel

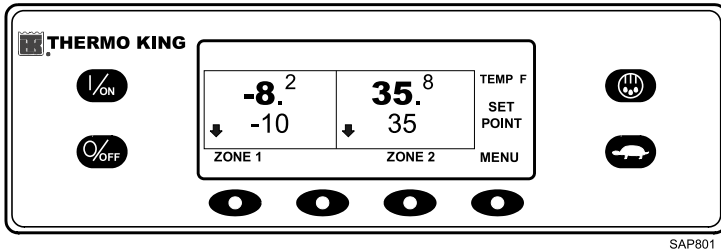
The display will briefly show PROGRAMMING LANGUAGE - PLEASE WAIT in the new language as shown (Figure 19, p. 33).

**Figure 19. Programming Language**



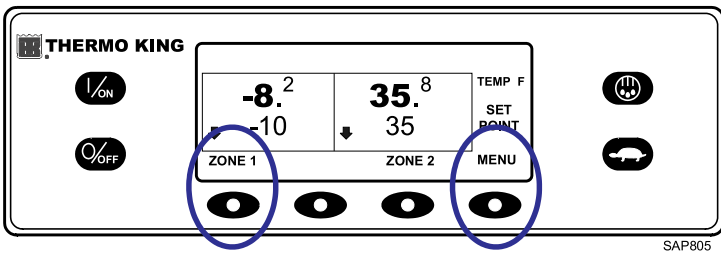
The new language is confirmed, and the Standard Display will appear in the new language as shown (Figure 20, p. 33). The unit is ready to run.

**Figure 20. Truck Premium HMI Control Panel**



Should it be necessary to change to another language at any time, return to the Standard Display and then press and hold the first and last soft keys for five seconds as shown (Figure 21, p. 33). The Standard Display below is shown in Deutsch (German).

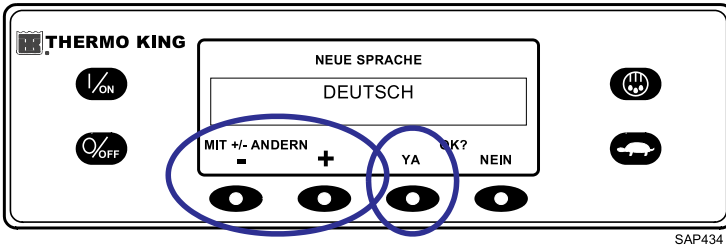
**Figure 21. First and Last Soft Keys**



## Operating Instructions for Premium HMI Control Panel

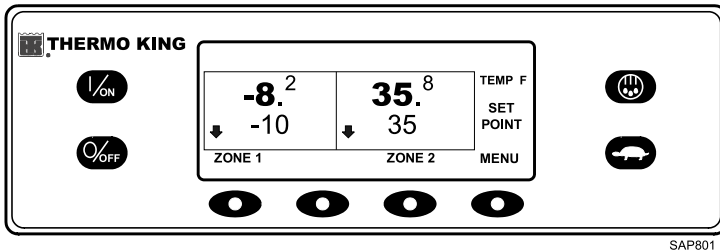
The Language menu will appear in the current language as shown (Figure 22, p. 34). Press the + or - keys to select the desired language. When the desired language is shown, press the YES key to confirm the choice. All languages in the installed software can be selected using this method.

**Figure 22. Language Menu**



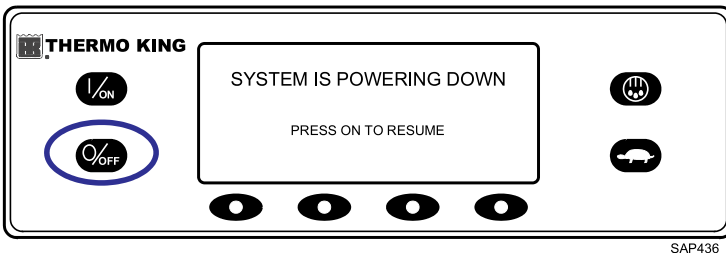
When the unit is ready to run, the Standard Display appears.

**Figure 23. Standard Display**



Pressing the OFF key stops unit operation. The unit shuts down immediately and the display briefly shows the power down message.

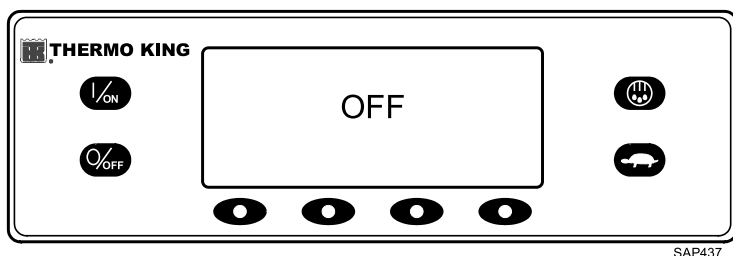
**Figure 24. Power Down Message**



## Operating Instructions for Premium HMI Control Panel

The display briefly shows OFF and then goes blank. To start the unit again, press the ON key.

**Figure 25. Off Display**

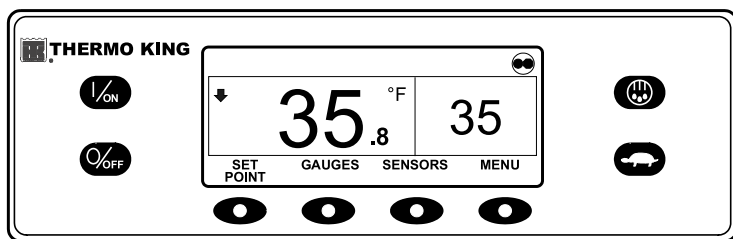


SAP437

### The Standard Display

The Standard Display is the default display that appears if no other display function is selected. The Standard Display shows the box temperature and setpoint. The box temperature is that measured by the controlling sensor, usually the return air sensor. The box temperature shown is 35.8°F with a 35° F setpoint.

**Figure 26. Standard Display**



SAP418

The CYCLE-SENTRY Icon in the upper right corner of the display shows that the unit is operating in CYCLE-SENTRY Mode. If the CYCLE-SENTRY Icon is not present, the unit is operating in Continuous Mode.

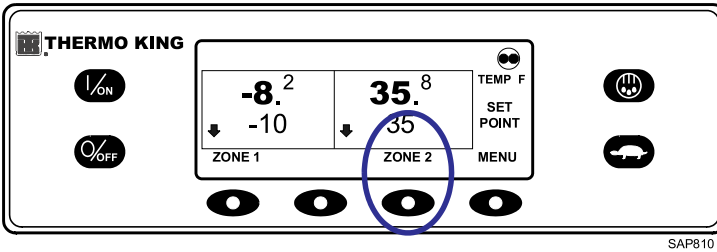
The down-pointing arrow indicates that the unit is cooling. If the unit was heating, the arrow would be pointing upward.

Pressing the left soft key allows the user to change the SETPOINT, and pressing the right soft key accesses the MAIN MENU. The other two soft keys access the GAUGES menu and the SENSORS menu.

## Changing the Setpoint

From the Standard Display, press the ZONE soft key for the desired zone. ZONE 2 is shown (Figure 27, p. 36).

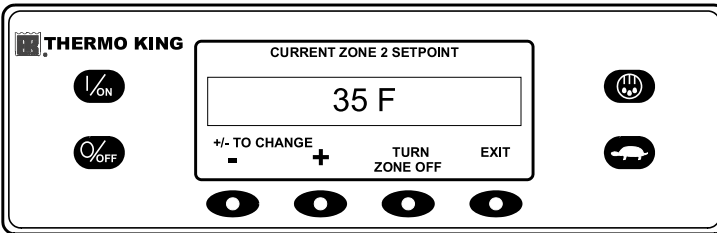
Figure 27. Zone Key



SAP810

The setpoint display appears as shown (Figure 28, p. 36).

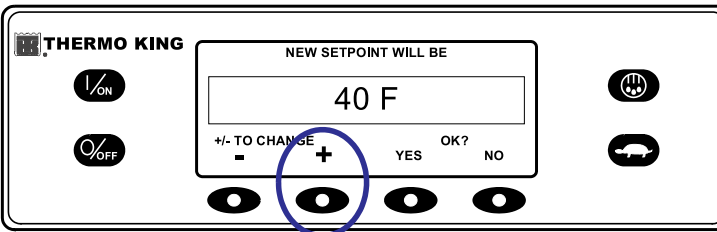
Figure 28. Setpoint Display



SAP811

The - and + soft keys are used to increase or decrease the setpoint until the desired setpoint is shown. The setpoint has been changed to 40°F using the + key (Figure 29, p. 36).

Figure 29. Increase Setpoint



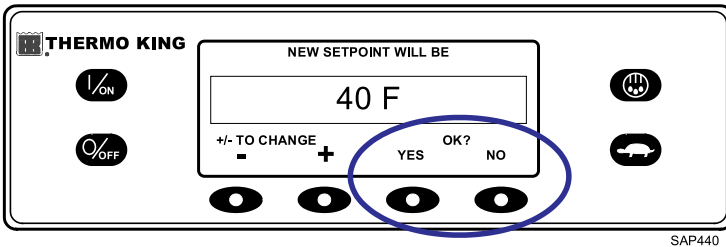
SAP439

## Operating Instructions for Premium HMI Control Panel

The YES and NO soft keys confirm the setpoint change. When the desired setpoint has been selected using the + and/or - keys, press the YES soft key to confirm and load the new setpoint. If the setpoint is changed using the + or - keys, the change must be confirmed or rejected by pressing the YES or NO soft key within 10 seconds of changing the setpoint.

Failure to confirm the new setpoint by pressing YES or NO within 10 seconds of changing the setpoint will result in no setpoint change. In addition, Alarm Code 127 Setpoint Not Entered is set, to indicate that the setpoint change was not completed.

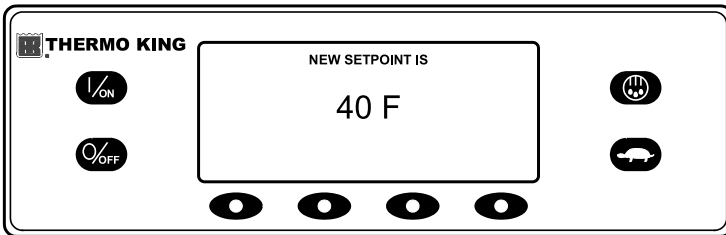
**Figure 30. YES/NO Soft Keys**



SAP440

After the YES soft key has been pressed, the display briefly shows PROGRAMMING NEW SETPOINT - PLEASE WAIT. The display then confirms the new setpoint for several seconds.

**Figure 31. New Setpoint**



SAP441

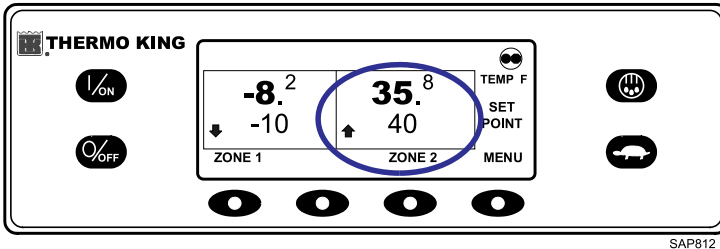
If the NO soft key is pressed, the display will briefly show SETPOINT NOT CHANGED and return to the Standard Display. The Standard Display will show the old setpoint. The display then returns to the Standard Display showing the new setpoint. The arrow now points up to indicate that the unit is heating (Figure 32, p. 38). The Zone 2 arrow now points up, to indicate that Zone 2 is heating.

## Operating Instructions for Premium HMI Control Panel

**Important:** If the setpoint is changed using the + or - keys, the change must be confirmed or rejected by pressing the YES or NO soft key within 10 seconds of changing the setpoint.

- If the YES key is pressed, the setpoint change made with the + or - key is accepted, the setpoint changes, and the display returns to the Standard Display.
- If the NO key is pressed, the setpoint change made with the + or - key is not accepted, the setpoint is not changed, and the display returns to the Standard Display.
- If either the YES or NO key is not pressed within 10 seconds of making a change with the + or - key, the setpoint is not changed, and the display returns to the Setpoint Display. The display briefly shows [SETPOINT NOT CHANGED] and Alarm Code 127 Setpoint Not Entered is set, to indicate that a setpoint change was started but not completed.

**Figure 32. Standard Display, New Setpoint**



## Starting the Diesel Engine

### ⚠ CAUTION

#### Risk of Injury!

The engine may start automatically any time the unit is turned on.

### NOTICE

#### Equipment Damage!

Never use starting fluid. Damage to the engine can occur.

Diesel engine preheats and starts are automatic in both Continuous Mode and CYCLE-SENTRY Mode. The engine will preheat and start as required when the unit is turned on. The engine preheat and start will be delayed in CYCLE-SENTRY mode if there is no current need for the engine to run. If any

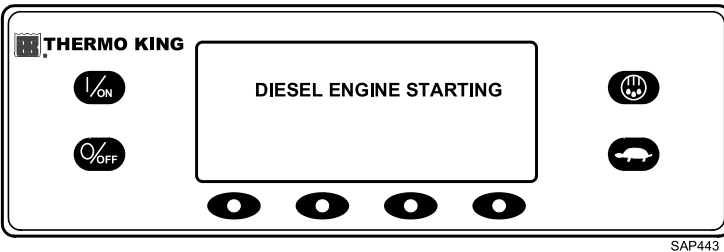
## Operating Instructions for Premium HMI Control Panel

keys are being pressed on the HMI Control Panel, the engine will not preheat and start until 10 seconds after the last key is pressed.

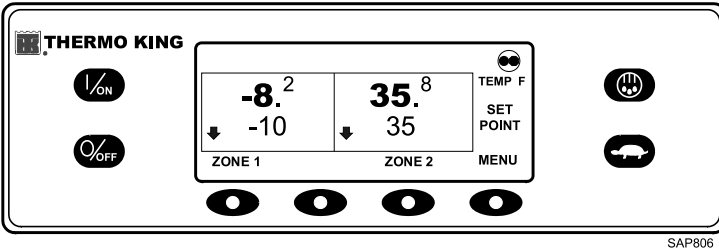
**Note:** *If the unit is equipped with optional Electric Standby, there may be some additional prompts before the engine will start. Refer to Starting the Electric Motor for details.*

When the engine is preparing to start, the HMI Control Panel will display the engine start screen (Figure 33, p. 39). The preheat buzzer sounds during the engine preheat and crank sequence.

**Figure 33. Engine Start Screen**



After the engine is started, the display returns to the Standard Display of temperature and setpoint.



## Starting the Electric Motor

**Note:** *Units equipped with the Electric Standby option only.*

### **⚠ CAUTION**

#### **Risk of Injury!**

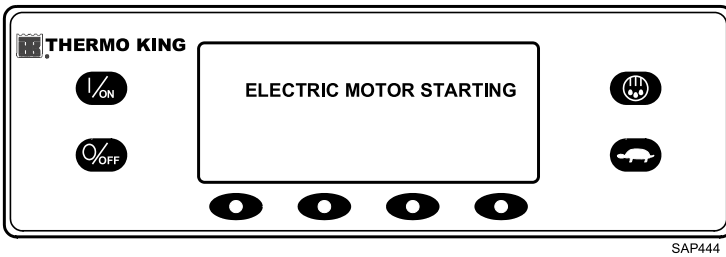
The motor may start automatically any time the unit is turned on.

## Operating Instructions for Premium HMI Control Panel

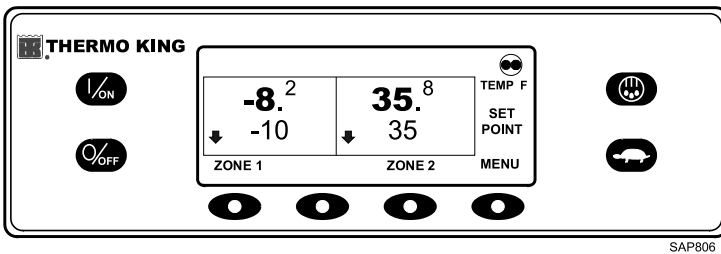
Electric motor starting is automatic in both Continuous Mode and CYCLE-SENTRY Mode. The motor will start as required when the unit is turned on. If any keys are being pressed on the HMI Control Panel prior to the motor start, the motor start will be delayed until 10 seconds after the last key is pressed.

When the motor is preparing to start, the HMI Control Panel will display the motor start screen (Figure 34, p. 40). The preheat buzzer sounds for 20 seconds before the electric motor starts.

**Figure 34. Motor Start Screen**



After the motor is running, the display returns to the Standard Display of temperature and setpoint.



## Switching from Diesel to Electric

**Note:** Units equipped with the Electric Standby option only.

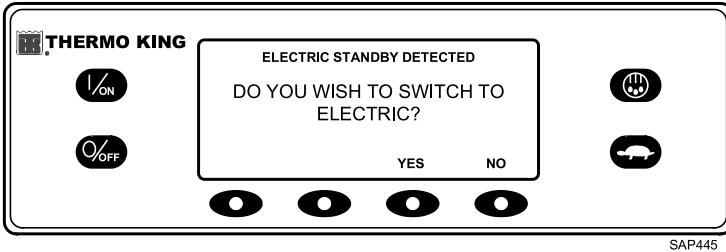
If the Diesel to Electric Autoswitch Enabled feature in Guarded Access is set YES, the unit will automatically switch to Electric Mode operation when standby power is connected and available.

If the Diesel to Electric Autoswitch Enabled feature in Guarded Access is set NO, the prompt screen shown (Figure 35, p. 41) will appear when standby power is connected and available.



## Operating Instructions for Premium HMI Control Panel

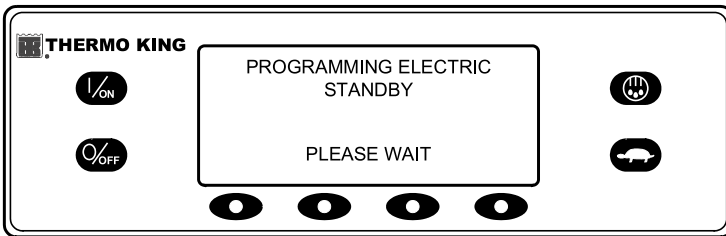
**Figure 35. Prompt Screen**



SAP445

If YES is selected, the display will briefly show the screen below (Figure 36, p. 41).

**Figure 36. Programming Screen**



SAP446

Electric Mode operation will briefly be confirmed. If unit operation is required, the electric motor will start as shown in Starting The Electric Motor.

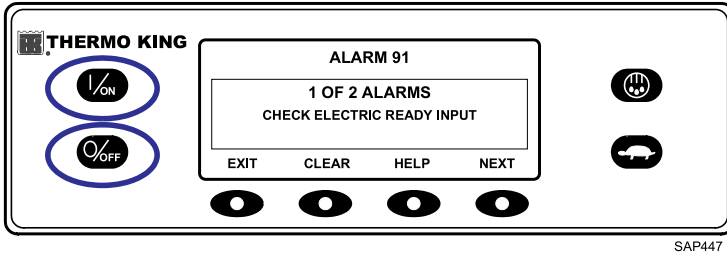
### Switching from Electric to Diesel

**Note:** Units equipped with the Electric Standby option only.

If the Electric to Diesel Autoswitch Enabled feature in Guarded Access is set YES, the unit will automatically switch to Diesel Mode operation when standby power is turned off or is no longer available.

If the Electric to Diesel Autoswitch Enabled feature in Guarded Access is set NO, the prompt screen (Figure 37, p. 42) will appear when standby power is turned off or is no longer available. Alarm Code 91 Check Electric Ready Input and Alarm Code 84 Restart Null will both be set.

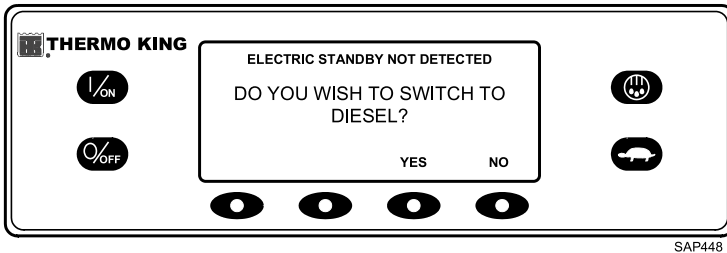
**Figure 37. Prompt Screen**



Turn the unit off and back on using the OFF and ON Keys. This will clear Alarm Code 91 Check Electric Ready Input and Alarm Code 84 Restart Null.

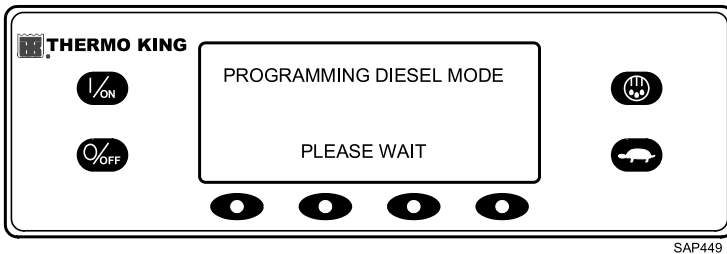
**Note:** The CLEAR Soft Key will not clear these two alarms. The prompt screen shown (Figure 38, p. 42) will appear.

**Figure 38. Prompt Screen**



If YES is selected, the display will briefly show the programming screen (Figure 39, p. 42). Diesel Mode operation will briefly be confirmed.

**Figure 39. Programming Screen**



## Operating Instructions for Premium HMI Control Panel

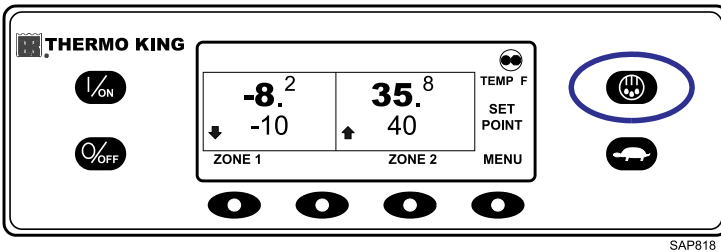
If unit operation is required, the diesel engine will start as shown previously in Starting The Diesel Engine.

### Initiating a Manual Defrost Cycle

Defrost cycles are usually initiated automatically based on time or demand. Manual defrost is only available if the zone is running and the zone evaporator coil temperature is less than or equal to 45°F (7°C). Other features such as door switch settings may not allow manual defrost under some conditions.

To initiate a manual defrost cycle, press the Defrost Key as shown (Figure 40, p. 43).

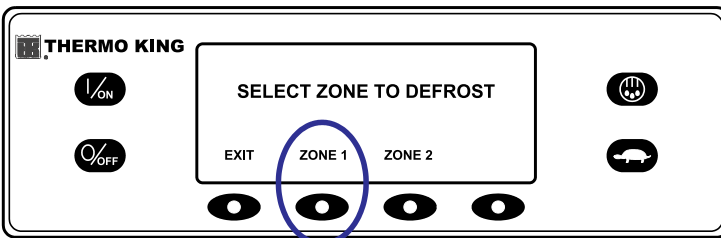
**Figure 40. Defrost Key**



SAP818

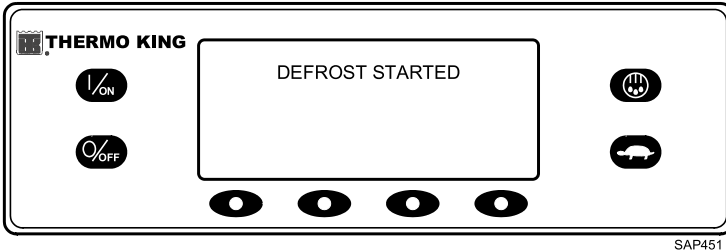
The display will briefly show [DEFROST]. The Zone Select display will appear. Zone 1 has been selected (Figure 41, p. 43).

**Figure 41. Select Zone**

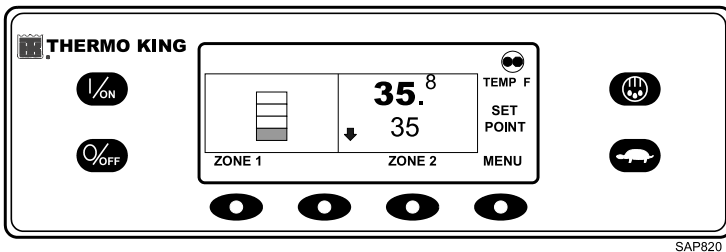


SAP819

The display briefly shows [DEFROST], [PROGRAMMING DEFROST - PLEASE WAIT] and then [DEFROST STARTED].

**Figure 42. Defrost Started**

The display then shows the Defrost display. The bar indicator shows approximately the percentage of time remaining to complete the defrost cycle. The bar indicator (Figure 43, p. 44) shows that the Zone 1 defrost cycle is approximately 25% complete.

**Figure 43. Defrost Display**

## Terminating a Defrost Cycle

The defrost cycle terminates automatically when the coil temperature is greater than or equal to 52°F (11°C) or the defrost timer expires. Defrost can also be terminated by turning the unit off and back on.

## Selecting High Speed Lockout Mode (If Enabled)

High speed operation can be locked out in noise sensitive areas if required.

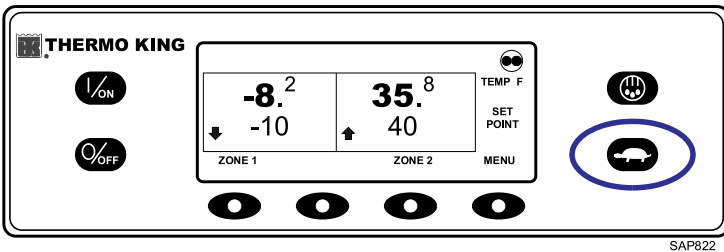
**Note:** *High Speed Lockout Enable must be set to [Enabled] in the Guarded Access/Programmable Features Menu or this feature will not be available.*

## Operating Instructions for Premium HMI Control Panel

**Important: HIGH SPEED LOCKOUT TIMEOUT:** If High Speed Lockout Mode is selected, the High Speed Inhibit Timeout feature may be set to return the unit to normal operation after a set time period has expired. This prevents extended operation with high speed operation locked out. The time period may be from 15 minutes to 2 hours. If the time period is set and is exceeded, the unit will return to normal operation, with high speed operation allowed. If this occurs, the message **HIGH SPEED LOCKOUT ACTIVE** at the top of the display will disappear. If necessary to return to High Speed Lockout Mode, press the High Speed Lockout Key again.

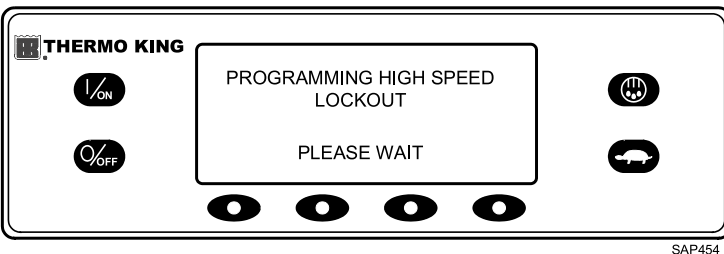
The High Speed Lockout Key is a toggle. If high speed is currently allowed, pressing the High Speed Lockout Key will disable high speed operation. Pressing the High Speed Lockout Key again will allow high speed operation. To change the setting, press the High Speed Lockout key as shown (Figure 44, p. 45).

**Figure 44. High Speed Lockout Key**



The display will briefly show [PROGRAMMING HIGH SPEED LOCKOUT - PLEASE WAIT].

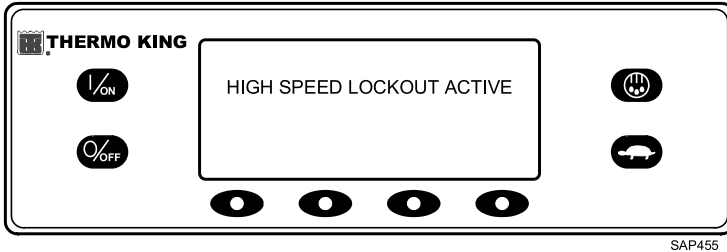
**Figure 45. Programming Screen**



## Operating Instructions for Premium HMI Control Panel

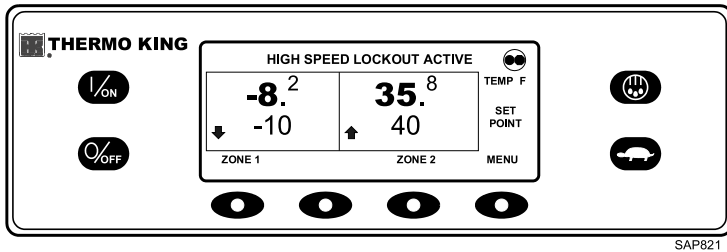
The change is confirmed by briefly displaying [HIGH SPEED LOCKOUT ACTIVE] or [HIGH SPEED LOCKOUT INACTIVE].

**Figure 46. High Speed Lockout Display**



The display will then return to the Standard Display. If High Speed Lockout is turned on, the message HIGH SPEED LOCKOUT ACTIVE will be shown at the top of the display.

**Figure 47. High Speed Lockout Active**



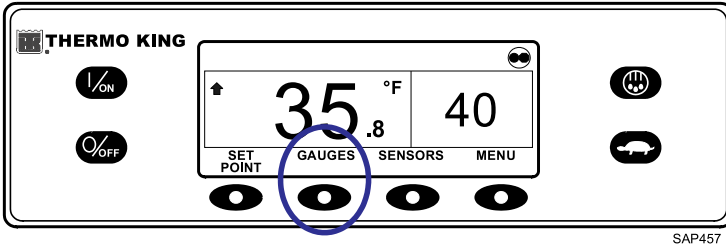
Pressing the High Speed Lockout key again will turn the feature off.

### Using the Gauges Key

The GAUGES key allows the operator to view the unit gauges. To access the GAUGES menu press the GAUGES key.

## Operating Instructions for Premium HMI Control Panel

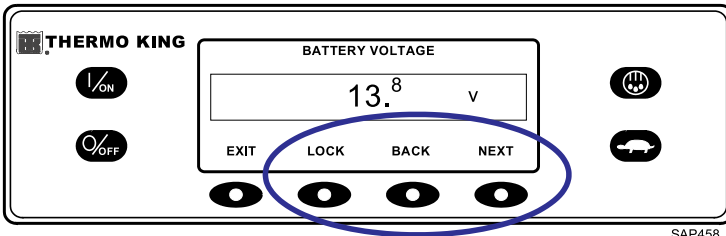
**Figure 48. Gauges Key**



SAP457

The first gauge display will appear. Press the NEXT and BACK keys to scroll through the gauges. The Battery Voltage Gauge is shown (Figure 49, p. 47). Press the LOCK key to lock the selected gauge on the display.

**Figure 49. Next, Back, Lock Keys**



SAP458

The gauges and I/O conditions available are shown below. The order in which the gauges appear may vary slightly based on software revision. Not all gauges may appear, depending on unit configuration and software revision.

To return to the Standard Display press the EXIT key.

### Gauges Available

**Coolant Temperature:** Displays the temperature of the engine coolant.

**Coolant Level:** Displays the coolant level in the overflow tank as OK or LOW.

**Engine Oil Pressure:** Displays the engine oil pressure as OK or LOW.

**Engine Oil Level:** Displays the engine oil level as OK or LOW.

**Amps:** Displays the current flow in amps flowing to or from the unit battery.

**Battery Voltage:** Displays the voltage of the unit battery.

## Operating Instructions for Premium HMI Control Panel

**Engine RPM:** Displays the engine speed in RPMs.

**Discharge Pressure:** Displays the unit discharge pressure.

**Suction Pressure:** Displays the unit suction pressure.

**ETV Position:** Displays the current position of the ETV valve. ETV units only.

**Compressor Temperature:** Displays the temperature sensed by the compressor temperature sensor. Scroll compressor only.

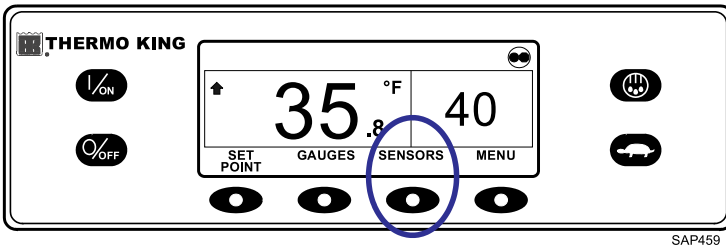
**I/O (Input/Output State):** Displays the current state of the input/output devices (ON or OFF) listed here:

High Speed Relay/Electric Heat	Hot Gas Solenoid	Condenser Inlet Solenoid
Run Relay	Alternator Frequency	Drain Hose Heater
Run Relay Feedback	Diesel/Electric Relay (Model 50 units only)	Purge Valve
Alternator Excite Output	Electric Ready Input (Model 50 units only)	
Defrost Damper	Electric Overload (Model 50 units only)	

### Using the Sensors Key

The SENSORS key allows the operator to view the temperatures read by the unit temperature sensors. To access the SENSORS menu press the SENSORS key.

**Figure 50. Sensors Key**

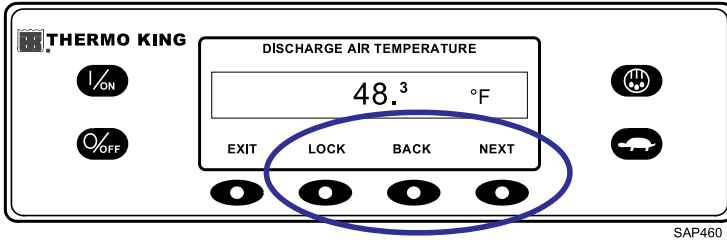


The first sensor display will appear. Press the NEXT and BACK keys to scroll through the sensors. The Discharge Air Temperature sensor is shown (Figure 51, p. 49). Press the LOCK key to lock the current sensor on the display.



# Operating Instructions for Premium HMI Control Panel

**Figure 51. Next, Back, Lock Keys**



The sensors available are shown below. To return to the Standard Display press the EXIT key.

## Sensors Available

**Return Air Temperature:** Displays the temperature of the control return air sensor.

**Discharge Air Temperature:** Displays the temperature of the control discharge air sensor.

**Temperature Differential:** Displays the calculated difference between the control return air sensor and the control discharge air sensor.

**Evaporator Coil Temperature:** Displays the temperature of the evaporator coil sensor.

**Ambient Air Temperature:** Displays the temperature of the ambient air sensor.

**Spare 1 Temperature:** Displays the temperature of the spare 1 temperature sensor.

**Data Logger Sensor 1 Temperature:** Displays the temperature of the Data Logger sensor 1.

**Data Logger Sensor 2 Temperature:** Displays the temperature of the Data Logger sensor 2.

**Data Logger Sensor 3 Temperature:** Displays the temperature of the Data Logger sensor 3.

**Data Logger Sensor 4 Temperature:** Displays the temperature of the Data Logger sensor 4.

**Data Logger Sensor 5 Temperature:** Displays the temperature of the Data Logger sensor 5.

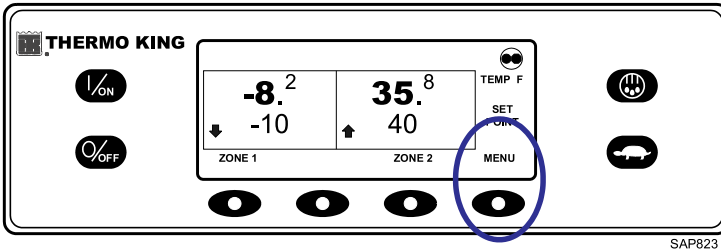
## Operating Instructions for Premium HMI Control Panel

**Data Logger Sensor 6 Temperature:** Displays the temperature of the Data Logger sensor 6.

### Using The Main Menu

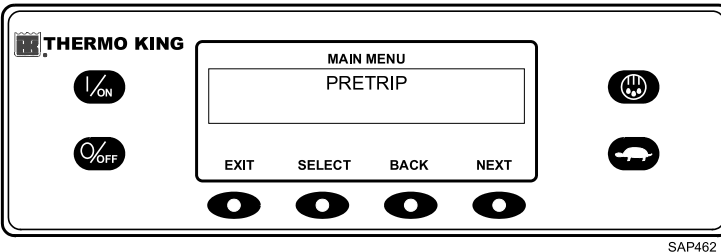
The Main Menu contains several additional submenus that allow the operator to view information and modify unit operation. To access the Main Menu press the MENU key.

**Figure 52. Menu Key**



The first Main Menu choice will appear. Press the NEXT and BACK keys to scroll through the menu choices. When the desired selection is shown on the display, press the SELECT key to access it. The Pretrip submenu is shown (Figure 53, p. 50). To return to the Standard Display press the EXIT key.

**Figure 53. Pretrip Submenu**



### Main Menu Choices

**Language Menu:** If more than one language is enabled, this will be the first menu item to appear. If only one language is enabled, this menu will not appear. The Language Menu allows the operator to select a language from a list of up to 11 languages at one time. All subsequent displays are shown in the selected language. Three different language packages with a total of 23

## Operating Instructions for Premium HMI Control Panel

---

languages are available. English is the default language and is provided in each of the packages.

**Alarms Menu:** Allows the operator to view all alarms, and allows most alarms to be cleared. If only one language is enabled, this will be the first menu item to appear.

**Gauges Menu:** Allows the operator to view the unit gauges and the state of the Inputs and Outputs on both the Interface Board and the Expansion Module.

**Sensors Menu:** Allows the operator to view the unit temperature sensors. If a DAS Data Logger is installed, the data logger sensors may also be viewed.

**Hourmeters Menu:** Allows the operator to view the unit hourmeters that have the view feature enabled in the Guarded Access Menu. If the view feature for a particular hourmeter is not enabled, that hourmeter will continue to accumulate time but cannot be viewed from the Main Menu. However, all hourmeters can be viewed from the Maintenance Menu, even if they are not enabled.

**Mode Menu:** Allows the operator to change the unit operating modes if allowed. Not all modes may appear depending on the settings selected from the Guarded Access menu and the HMI Control Panel software version.

- Turn Off CYCLE-SENTRY Mode/Turn On CYCLE-SENTRY Mode (If CYCLE-SENTRY is Off unit runs in Continuous).
- Allows Temperature Units to be selected as Fahrenheit or Celsius.
- Allows Single Zone Control or Multi Zone Control to be selected.
- Allow Keypad Lock-Out to be selected.
- Allows Sleep Mode to be entered.

**Pretrip Menu:** Allows the operator to start a Pretrip Test. If an alarm is active, the Pretrip Test is not allowed and the operator is prompted to clear the alarm(s).

**Electric Standby Menu:** If the Electric Standby option is present and the Diesel to Electric Auto-switch feature is set NO, this feature allows the operator to manually select electric mode operation. This feature does not appear if the unit does not feature optional Electric Standby or if the Diesel to Electric Auto-switch feature is set YES.

**Diesel Mode Menu:** If a unit equipped with electric standby is running in electric mode and the Electric to Diesel Auto-switch feature is set NO, this feature allows the operator to manually select diesel mode operation. This feature does not appear if the unit does not feature optional Electric Standby or if the Electric to Diesel Auto-switch feature is set YES.

## Operating Instructions for Premium HMI Control Panel

---

**Adjust Brightness Menu:** Allows the operator to adjust the HMI Control Panel display backlight intensity as required by local conditions.

**Time Menu:** Allows the operator to view the unit time and date. The time and date cannot be changed from this menu.

### Languages Menu

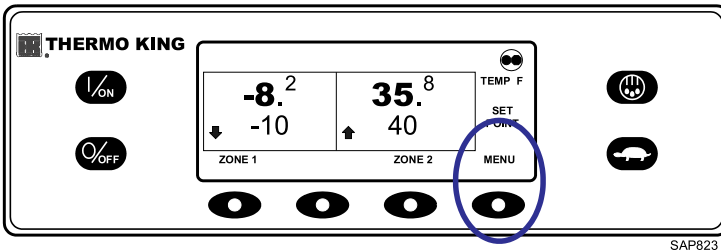
If the Language feature is enabled, an alternate language can be selected from the Language Menu. After a new language is chosen, all subsequent displays will appear in that language. If the language feature is not enabled, this menu does not appear. The default language is English. Only languages that have been enabled in Guarded Access will appear. Exercise care when changing languages, once changed, all HMI Control Panel displays will be in the new language. If the user is not familiar with the new language, problems may be experienced returning to the default language.

**Mix and Match Language Feature:** Software revision 68xx allows any five languages from both the 65/75xx and 66/76xx to be enabled. Japanese and Chinese are not available for use with this feature.

**Note:** *WinTrac 4.8.1 or later is required to use the Mix and Match Language Feature.*

To select an alternate language, press the MENU key.

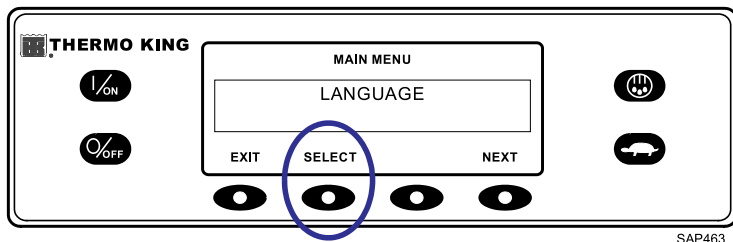
**Figure 54. Menu Key**



If enabled, the Language Menu is the first menu item to appear as shown (Figure 55, p. 53). Press the SELECT key to choose the Language menu.

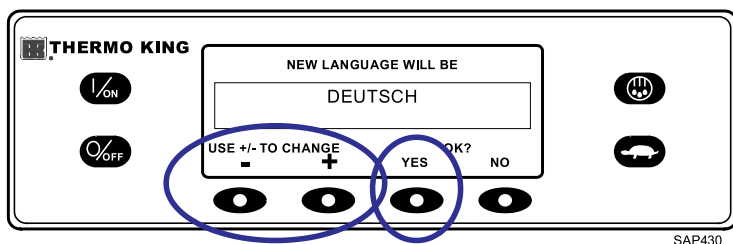
## Operating Instructions for Premium HMI Control Panel

**Figure 55. Select Key**



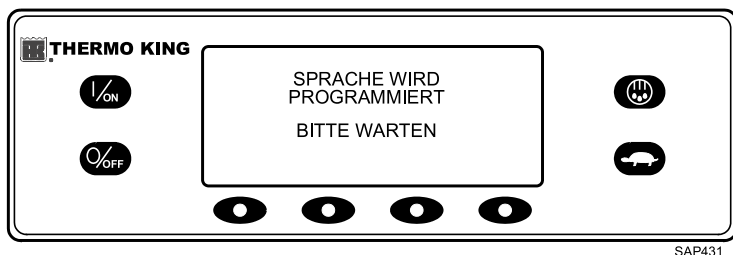
The Language menu will appear as shown (Figure 56, p. 53). Press the + or - keys to select the desired language. When the desired language is shown, press the YES key to confirm the choice.

**Figure 56. + or - Keys, Yes Key**



The display will briefly show PROGRAMMING LANGUAGE - PLEASE WAIT in the new language as shown (Figure 57, p. 53).

**Figure 57. New Language**

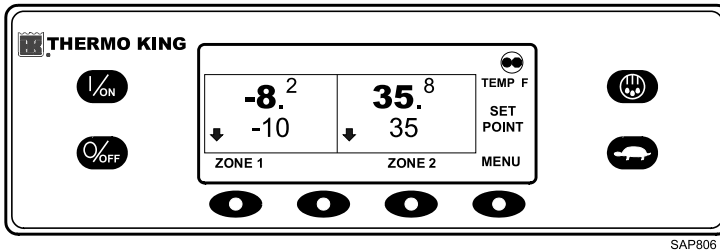


The new language is confirmed, and then the Standard Display will appear in the new language as shown (Figure 58, p. 54).

## Operating Instructions for Premium HMI Control Panel

**Note:** The Standard Display in Deutsch (German) is the same as in English.  
The unit is ready to run.

**Figure 58. Standard Display**

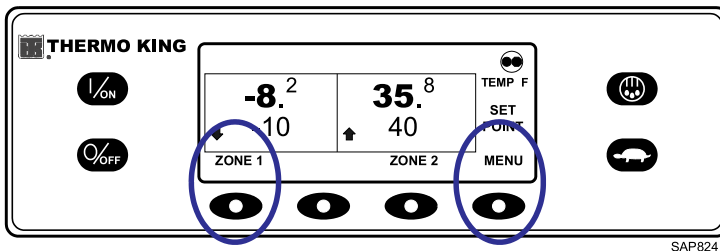


Repeat the process to select a different language. To select a different Main Menu item, press the NEXT key. To return to the Standard Display press the EXIT key.

**Important:** If necessary, English and all other languages in the installed HMI Control Panel software revision may be accessed from the Standard Display.

Should it be necessary to change to another language at any time, return to the Standard Display and press and hold the first and last soft keys for five seconds as shown (Figure 59, p. 54).

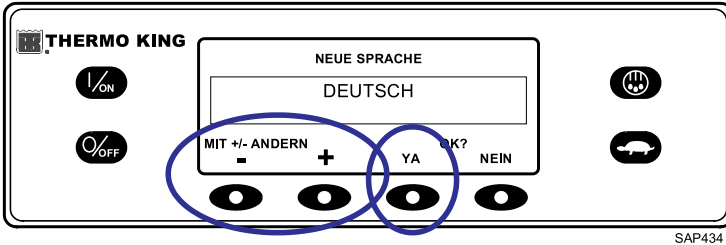
**Figure 59. Standard Display**



After five seconds, the Language Menu will appear in the current language as shown (Figure 60, p. 55). Press the + or - keys to select the desired language. When the desired language is shown, press the YES key to confirm the choice. All languages in the installed HMI Control Panel software can be selected using this method.

## Operating Instructions for Premium HMI Control Panel

**Figure 60. Language Menu**



SAP434

## Alarms

Alarms may be one of four types as shown.

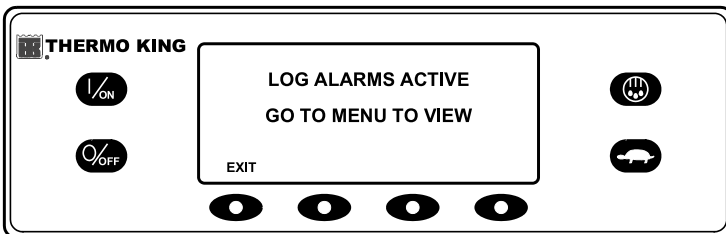
### Log Alarms

Log Alarms are indicated for 60 seconds each time the unit is turned on. This level of alarm serves as a notice to take corrective action before the condition impacts unit performance. Maintenance items such as maintenance hourmeter time-outs are Log Alarms.

When the unit is turned on, the display will show the Thermo King Logo and the "Configuring System" message. If Log Alarm(s) are present, the Log Alarm notice will appear on the display for 60 seconds as shown (Figure 61, p. 55). The amber K symbol of the remote indicator alarm light (if installed) will also be on during this period. The Standard Display will appear and the remote indicator alarm light will go to the white T symbol after 60 seconds.

**Note:** The Alarm Icon does not appear on startup with log alarms present.

**Figure 61. Log Alarm Notice**



SAP464

**Note:** If required, an engine start may occur while the Log Alarm Notice is shown (Figure 61, p. 55). This is normal operation.

## Check Alarms

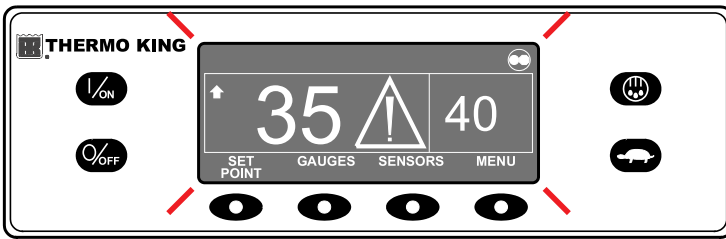
Check Alarms are indicated by an Alarm Icon in the display. The amber K symbol of the remote indicator alarm light (if installed) will be on. This level of alarm serves as a notice to take corrective action before a problem becomes severe. The unit will run with check alarms but some features and functions may be inhibited.

## Shutdown Alarms

Shutdown Alarms will be set if continued operation could cause damage to the unit or the load. Shutdown Alarms are indicated by the following:

- The Alarm Icon will appear in the display.
- The display and backlight will flash on and off.
- The display will switch from normal to inverted and back to normal (light areas become dark and dark areas become light).
- The remote indicator alarm light (if installed) will display only a row of LEDs at the bottom.

**Figure 62. Shutdown Alarm**



SAP466

Shutdown Alarms will force the unit into shutdown to prevent potential damage to the unit or load. The unit will remain in shutdown until the Shutdown Alarm is manually cleared. Exceptions are some engine and electric Shutdown Alarms that become Log Alarms when switched to the alternate operating mode (diesel to electric or electric to diesel).

## Prevent Alarms

Prevent Alarms are also indicated by a steady Alarm Icon in the display. The remote indicator alarm light (if installed) will be on. The unit will attempt to resolve the situation as shown below:

- The unit will be temporarily shut down if a Prevent Alarm is active.



## Operating Instructions for Premium HMI Control Panel

---

- The unit will remain shut down for a timed restart interval or until the fault conditions are corrected.
- If the unit is in a temporary shutdown, Alarm Code 84 Restart Null will be present along with the associated Prevent Alarm.
- The unit will restart and run (in most cases with forced reduced performance) to determine if continued operation is possible. The unit will run in this manner for a timed interval. If the unit is running with forced reduced performance, Alarm Code 85 Forced Unit Operation will also be present under some conditions.
- If the alarm does not re-occur during the timed running interval with reduced performance, the unit will return to full performance to determine if continued operation is possible. The unit will run in this manner for a timed interval. If the unit is successfully able to return to full performance for the timed interval without the alarm re-occurring, the alarm is auto cleared and the unit will run normally.
- All Prevent Alarm events and conditions are logged by the ServiceWatch Data Logger.
- In general, if the alarm condition re-occurs a defined number of times, the alarm is set as a Shutdown Alarm and no further restarts are possible.

**Note:** *If the Restart After Shutdown feature in the Guarded Access Menu is set for CONTINUOUS, an unlimited number of restart attempts are allowed.*

### Pretrip Alarm Codes

If an alarm occurs during a Pretrip Test, the alarm code will be displayed as Pretrip Alarm XX, where XX is the alarm code.

### Alarm Codes When Switching Between Diesel and Electric

If a Shutdown Alarm occurs that affects only diesel mode operation and the unit is switched to electric, the diesel mode Shutdown Alarm becomes an electric mode Log Alarm. This allows the unit to run in electric mode without clearing the Shutdown Alarm that is preventing diesel mode operation. If the unit is switched back to diesel mode, the alarm again become a diesel mode Shutdown Alarm and prevents unit operation.

In the same manner, if a Shutdown Alarm occurs that affects only electric mode operation and the unit is switched to diesel, the electric mode Shutdown Alarm becomes a diesel mode Log Alarm to allow diesel mode operation. If the unit is switched back to electric mode, the alarm reverts to an electric mode Shutdown Alarm and prevents unit operation. If the unit is

## Operating Instructions for Premium HMI Control Panel

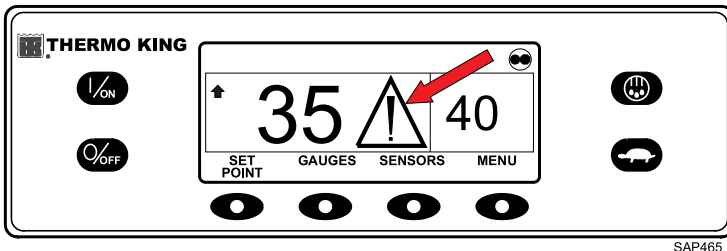
---

configured for electric to diesel autoswitch, it automatically starts and runs in diesel mode if an electric shutdown occurs.

### Alarm Code Notification

The Alarm Icon used in previous Thermo King controllers has been incorporated. If a Check Alarm condition occurs, the Alarm Icon will appear in the display as shown (Figure 63, p. 58).

**Figure 63. Alarm Icon**



### Clearing Alarm Codes

Most alarm codes can be cleared conventionally from the Alarm Menu using the CLEAR key.

The following control and display sensor alarm codes can only be cleared from the Maintenance Menu or Guarded Access Menu:

- Alarm Code 03 Check Control Return Air Sensor
- Alarm Code 04 Check Control Discharge Air Sensor
- Alarm Code 74 Controller Reset to Defaults

The following alarm codes clear automatically:

- Alarm Code 64 Pretrip Reminder - Clears when a Pretrip Test is performed.
- Alarm Code 84 Restart Null - Clears when the unit is no longer in a restart null due to a Prevent Alarm.
- Alarm Code 85 Forced Unit Operation - Clears when the unit is no longer running in a forced mode due to a Prevent Alarm.
- Alarm Code 91 Check Electric Ready Input - Clears automatically when the unit starts running.
- Alarm Code 92 Sensor Grades Not Set - Clears when the sensor grade is changed from 5H.

## Operating Instructions for Premium HMI Control Panel

If the Limited Alarm Restarts feature is enabled, the following additional alarm codes may only be cleared from the Guarded Access Menu. If this is the case, the CLEAR soft key will not appear if the alarms are displayed from the Main Menu or the Maintenance Menu.

- Alarm Code 23 Cooling Cycle Fault
- Alarm Code 24 Heating Cycle Fault
- Alarm Code 32 Refrigeration Capacity Low
- Alarm Code 82 Compressor Temperature Shutdown
- Alarm Code 93 Low Compressor Suction Pressure

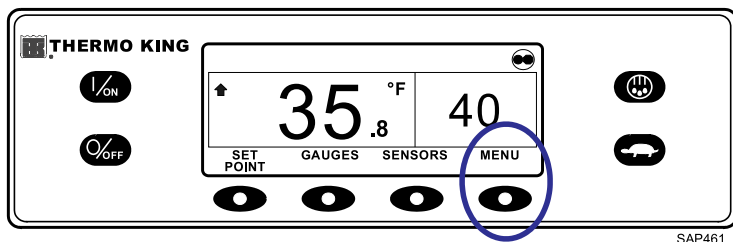
If the Limited Alarm Restarts II feature is enabled, the following additional alarm codes may only be cleared from the Guarded Access Menu. If this is the case, the CLEAR soft key will not appear if the alarms are displayed from the Main Menu or the Maintenance Menu.

- Alarm Code 18 High Engine Coolant Temperature

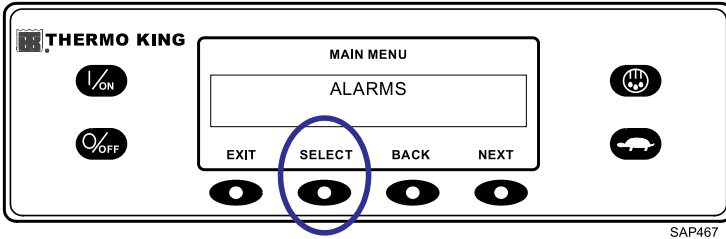
### Displaying and Clearing Alarm Codes

Alarms are displayed and cleared using the Alarm Menu. From the Standard Display, press the MENU key.

**Figure 64. Menu Key**

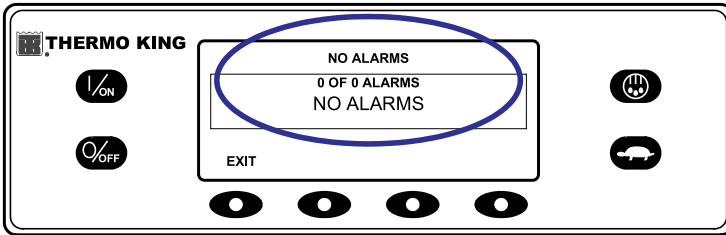


The Language Menu or Alarms Menu will appear. If the Language Menu appears, press the NEXT key to show the Alarm Menu. When the Alarm Menu is shown, press the SELECT key.

**Figure 65. Select Key**

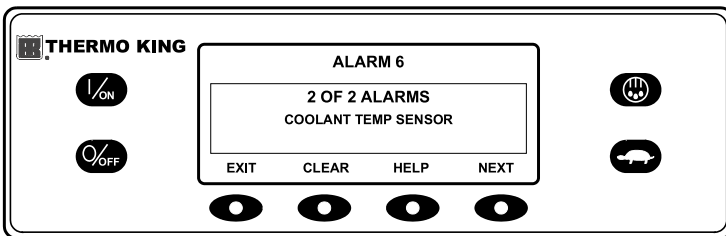
SAP467

The Alarm Display will appear. If no alarms are present, NO ALARMS will be shown.

**Figure 66. No Alarms**

SAP468

If alarms are present, the quantity of alarms (if more than one) and the most recent alarm code number will be shown. In the example shown (Figure 67, p. 60), there are two alarms present. The most recent is Alarm Code 6. It indicates a problem with the coolant temperature sensor.

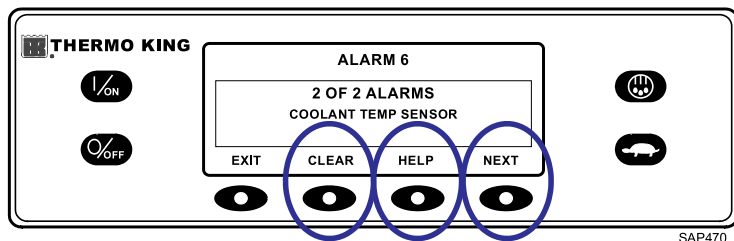
**Figure 67. Alarm Code 6**

SAP469

## Operating Instructions for Premium HMI Control Panel

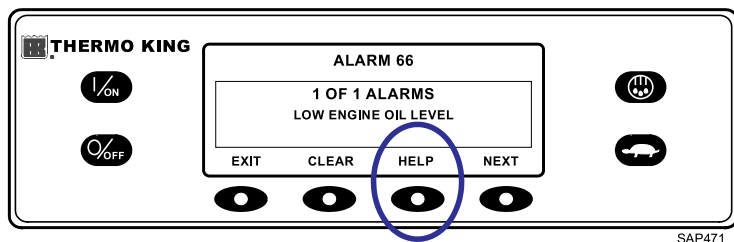
After the alarm situation is resolved, press the CLEAR key to clear the alarm. For additional information regarding the alarm shown on the display, press the HELP key. To display the next alarm, press the NEXT key.

**Figure 68. Next Key**



If a serious condition occurs, the unit will be shut down to prevent damage to the unit or the load. If this occurs, the display will show that the unit is shut down and display the alarm code that caused the shutdown. In the example shown (Figure 69, p. 61), the unit is shut down due to low engine oil level. For additional information regarding the alarm shown on the display, press the HELP key.

**Figure 69. Help Key**



A help message will appear. For the alarm shown (Figure 69, p. 61), the message "CHECK OIL LEVEL. IF UNIT IS SHUT DOWN, REPAIR IMMEDIATELY. OTHERWISE, REPORT ALARM AT END OF THE DAY" will be shown on the display. Check the oil level and add oil as required, clear the alarm and restart the engine.

To select a different Main Menu item, press the NEXT key. To return to the Standard Display, press the EXIT key.

### Important Alarm Notes

## Operating Instructions for Premium HMI Control Panel

---

- If an alarm will not clear, it may still exist. If the alarm is not corrected, it will not clear or may be immediately set again.
- If an alarm cannot be cleared from the Main Menu, the Clear key will not appear. These alarms must be cleared from the Maintenance or Guarded Access Menus.
- All alarms must be viewed before any of the alarms can be cleared.

### Table of Alarm Codes

**Important:** Alarm notes:

- If an alarm will not clear, it may still exist. If the alarm is not corrected, it will not clear or may be immediately set again.
- Some alarms cannot be cleared using the HMI Controller. These alarms must be cleared by maintenance personnel using PC Monitor.
- Not all alarm codes may be used with all applications.

NUM	Description	Operator Action
00	No Alarm Exist	No action required.
02	Check Evaporator Coil Sensor	Manually monitor load temperature. Report alarm at end of the day.
03	Check Return Air Sensor	Manually monitor load temperature. Report alarm at end of the day.
05	Check Ambient Air Sensor	Report alarm at end of the day.
06	Check Coolant Temp Sensor	Report alarm at end of the day.
07	Check Engine RPM Sensor	Report alarm at end of the day.
08	Unit Controlling on Coil Sensor	Manually monitor load temperature. Report alarm at end of the day
09	High Evaporator Temperature	Manually monitor load temperature. Report alarm at end of the day.
10	High Discharge Pressure	If unit is shut down repair immediately. Otherwise, report alarm at end of the day.
11	Unit Controlling on Alternate Sensor	Manually monitor load temperature. Report alarm at end of the day.
12	Sensor Shutdown	Both Return Air Temperature and Discharge Air Temperature sensors have failed and unit is shut down. Repair immediately.

## Operating Instructions for Premium HMI Control Panel

13	Sensor Calibration Check	Manually monitor load temperature. Report alarm at end of the day.
17	Engine Failed to Crank	If unit is shut down repair immediately. Otherwise, report alarm at end of the day.
18	High Engine Coolant Temperature	If unit is shut down repair immediately. Otherwise, report alarm at end of the day.
19	Low Engine Oil Pressure	If unit is shut down repair immediately. Otherwise, report alarm at end of the day.
20	Engine Failed to Start	If unit is shut down repair immediately. Otherwise, report alarm at end of the day.
21	Cooling Cycle Check	Manually monitor load temperature. Report alarm at end of the day.
22	Heating Cycle Check	Manually monitor load temperature. Report alarm at end of the day.
23	Cooling Cycle Fault	The indicated zone is not longer able to operate and has been shut down.
24	Heating Cycle Fault	The indicated zone is not longer able to operate and has been shut down.
25	Alternator Check	If unit is shut down repair immediately. Otherwise, report alarm at end of the day.
26	Check Refrigeration Capacity	Manually monitor load temperature. Report alarm at end of the day.
28	Pretrip or Self Check Abort	Report alarm at end of the day.
31	Check Oil Pressure Switch	If unit is shut down repair immediately. Otherwise, report alarm at end of the day.
32	Refrigeration Capacity Low	The indicated zone is not longer able to operate and has been shut down. Repair immediately.
33	Check Engine RPM	Report alarm at end of the day.
35	Check Run Relay Circuit	If unit is shut down repair immediately. Otherwise, report alarm at end of the day.

## Operating Instructions for Premium HMI Control Panel

36	Electric Motor Failed to Run	If unit is shut down repair immediately. Otherwise, report alarm at end of the day.
37	Check Engine Coolant Level	Report alarm at end of the day.
38	Electric Phase Reversed	If unit is shut down repair immediately. Otherwise, report alarm at end of the day.
42	Unit Forced to Low Speed	Report alarm at end of the day.
48	Check Belts or Clutch	If unit is shut down repair immediately. Otherwise, report alarm at end of the day.
50	Reset Clock	Report alarm at end of the day.
54	Test Mode Timeout	Service Test or Interface Board Test timed out after 15 minutes. Report alarm at end of the day.
61	Low Battery Voltage	If unit is shut down repair immediately. Otherwise, report alarm at end of the day.
63	Engine Stopped	If unit is shut down repair immediately. Otherwise, report alarm at end of the day.
64	Pretrip Reminder	Report alarm at end of the day.
66	Low Engine Oil	Check engine oil level. If unit is shut down repair immediately. Otherwise, report alarm at end of the day.
67	Internal Controller Fault Code	Report alarm at end of the day.
68	Internal Controller Fault Code	Report alarm at end of the day.
70	Hourmeter Failure	Report alarm at end of the day.
74	Controller Reset to Defaults	Report alarm at end of the day
84	Restart Null	Report alarm at end of the day.
90	Electric Overload	If unit is shut down repair immediately. Otherwise, report alarm at end of the day.
91	Check Electric Ready Input	If unit is shut down repair immediately. Otherwise, report alarm at end of the day.



## Operating Instructions for Premium HMI Control Panel

117	Auto Switch from Diesel to Electric	Report alarm at end of the day.
118	Auto Switch from Electric to Diesel	Auto Switch from Diesel to Electric
127	Setpoint Not Entered	Be sure the setpoint is set to the required Temperature.
128	Engine Run Time Maintenance Reminder #1	Report alarm at end of the day.
129	Engine Run Time Maintenance Reminder #2	Report alarm at end of the day.
130	Electric Run Time Maintenance Reminder #1	Report alarm at end of the day.
131	Electric Run Time Maintenance Reminder #2	Report alarm at end of the day.
132	Total Unit Run Time Maintenance Reminder #1	Report alarm at end of the day.
133	Total Unit Run Time Maintenance Reminder #2	Report alarm at end of the day.
134	Controller Power On Hours	Report alarm at end of the day.
145	Loss of Controller ON Feedback Signal	If unit is shut down repair immediately. Otherwise, report alarm at end of the day.
165	Low Engine Power Available	Report alarm at end of the day.

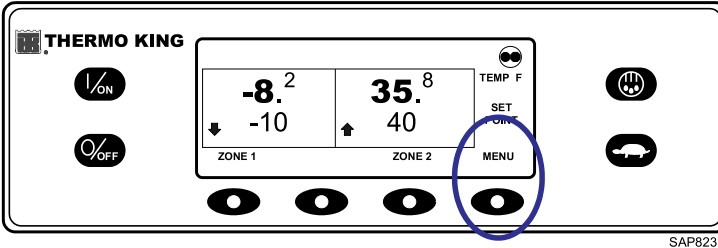
### Datalogger Menu

The unit can be equipped with an optional DAS Data Logger if desired.

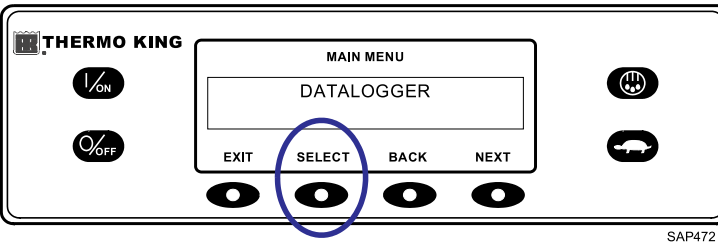
A Start of Trip marker can be sent to the unit ServiceWatch Data Logger and the optional DAS Data Logger (if equipped).

If equipped with the optional DAS Data Logger, the most recent DAS trip record can be printed. The most recent trip is defined as the trip following the last Start of Trip marker sent to the data logger.

The ServiceWatch Data Logger and DAS Data Logger (if equipped) are accessed using the Data Logger Menu. From the Standard Display, press the MENU key.

**Figure 70. Menu Key**

The Language Menu or Alarm Menu will appear. Press the NEXT key as required to display the Data Logger Menu. When the Data Logger Menu is shown, press the SELECT key.

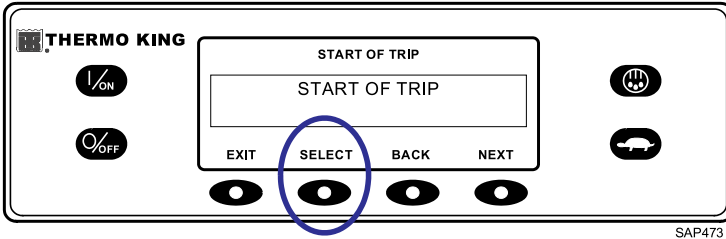
**Figure 71. Select Key**

The first feature that appears is the Start of Trip. To send a Start of Trip to the ServiceWatch Data Logger and DAS Data Logger (if equipped), press the SELECT key to select the feature, and press it again to send the Start of Trip. The display will briefly show START OF TRIP COMPLETE to confirm that a Start of Trip marker was set in the data logger(s).

**Note:** The start of trip marker is sent to both the ServiceWatch Data Logger and DAS Data Logger (if equipped).

## Operating Instructions for Premium HMI Control Panel

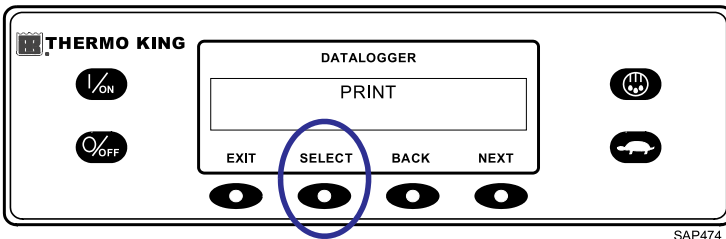
**Figure 72. Start of Trip**



SAP473

Press the NEXT key to select the PRINT feature. The PRINT screen will appear. Press the SELECT key to print the most recent trip record to the optional remote printer. Pressing the EXIT key returns the display to the Main Menu.

**Figure 73. Select Key**

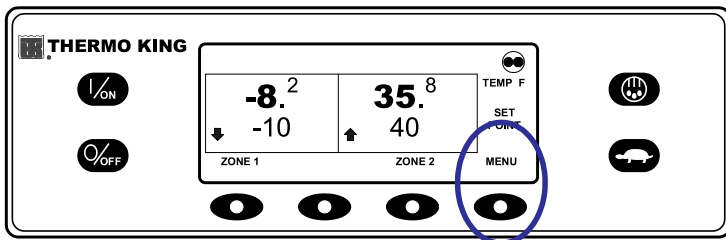


SAP474

## Hourmeters Menu

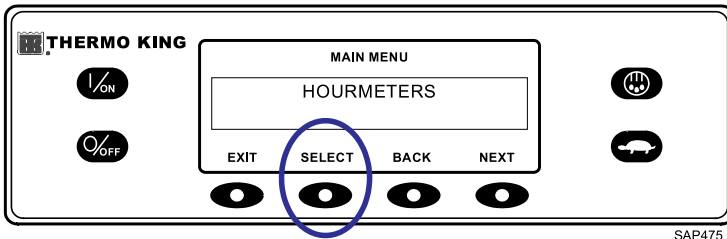
Hourmeters are displayed using the Hourmeter Menu. Only hourmeters enabled in the Guarded Access Menu will be shown. From the Standard Display, press the MENU key.

**Figure 74. Menu Key**

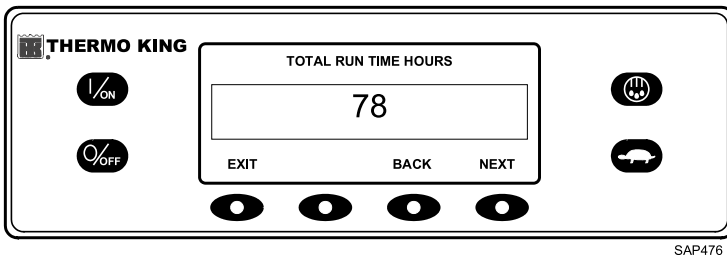


SAP823

The Language Menu or Alarm Menu will appear. Press the NEXT key as required to display the Hourmeter Menu. When the Hourmeter Menu is shown, press the SELECT key. The Hourmeter Display will appear.

**Figure 75. Hourmeter Display**

Press the NEXT or PREVIOUS key to scroll through the enabled hourmeters.

**Figure 76. Hourmeters**

## Hourmeter Names and Definitions

Hourmeter names and definitions are shown in the order they appear. Only hourmeters enabled in the Guarded Access Menu will be shown. To return to the Standard Display, press the EXIT key.

**Important:** *If a programmable hourmeter is not enabled or the view for that hourmeter is not turned on, it will not appear in the display sequence.*

- **Total Hours:** Total number of hours the unit has been turned on (protection hours).
- **Total Run Time Hours:** Total number of hours the unit has run in both diesel and electric mode.
- **Engine Hours:** Total number of hours the unit has run in diesel mode.

## Operating Instructions for Premium HMI Control Panel

---

- **Electric Run Hours:** Total number of hours the unit has run in electric mode.
- **Zone 1 Run Time Hours:** Total number of hours Zone 1 has run in both diesel and electric mode.
- **Zone 2 Run Time Hours:** Total number of hours Zone 2 has run in both diesel and electric mode.
- **Zone 3 Run Time Hours:** Total number of hours Zone 3 has run in both diesel and electric mode.
- **Total Run Reminder 1:** User Programmable - The number of hours before a Total Unit Run Time Maintenance Reminder 1 occurs.
- **Total Run Reminder 2:** User Programmable - The number of hours before a Total Unit Run Time Maintenance Reminder 2 occurs.
- **Controller Power On:** Total hours the controller and HMI control panel have been turned on.
- **Pretrip Reminder:** User Programmable - The number of hours before a Pretrip Reminder occurs.
- **Engine Reminder 1:** User Programmable - The number of hours before an Engine Run Time Maintenance Reminder 1 occurs.
- **Engine Reminder 2:** User Programmable - The number of hours before an Engine Run Time Maintenance Reminder 2 occurs.
- **Electric Reminder 1:** User Programmable - The number of hours before an Electric Run Time Maintenance Reminder 1 occurs.
- **Electric Reminder 2:** User Programmable - The number of hours before an Electric Run Time Maintenance Reminder 2 occurs.

### Mode Menu

Various operating modes can be selected using the Mode Menu. Not all modes may be available, depending on settings of other programmable features. The following modes may be available.

- **Turn CYCLE-SENTRY On or Off**

CYCLE-SENTRY Mode can be turned On or Off. If CYCLE-SENTRY Mode is turned Off, the unit will run in Continuous Mode.
- **Select Temperature Display Units**

If enabled in Guarded Access, temperature display units can be selected by the driver to be either Fahrenheit or Celsius degrees.
- **Single Zone Control - Multi Zone Control**

## Operating Instructions for Premium HMI Control Panel

---

If enabled in Guarded Access, Single Zone Control allows single temperature operation. If Single Zone Control operation is selected, all zones will be forced on and will control to the same setpoint. All bulkheads should be taken down to create one large compartment. Multi Zone Control allows separate control for each configured zone. For additional details, refer to Operating the Unit in Single Zone Mode earlier in this section.

- **Keypad Lockout**

If enabled in Guarded Access, the keypad can be locked to prevent unauthorized use. If the keypad is locked, only the ON and OFF keys function. The keypad will remain locked even if the unit is turned Off and back on. If Keypad Lockout is active, press and hold any soft key for five seconds to deactivate the feature.

- **Start Sleep Mode**

If enabled in Guarded Access, Sleep Mode is used to keep the engine warm and the battery charged when the unit is not in use. When the unit is in Sleep Mode, the display will show "SLEEP" and the current time. When Sleep Mode is entered, the unit will start and run to confirm proper battery charge level and engine temperature.

**Important:** *While in Sleep Mode, the unit will not monitor or maintain setpoint and load temperature. Fuel level should be monitored as the unit may run periodically, particularly in cold weather.*

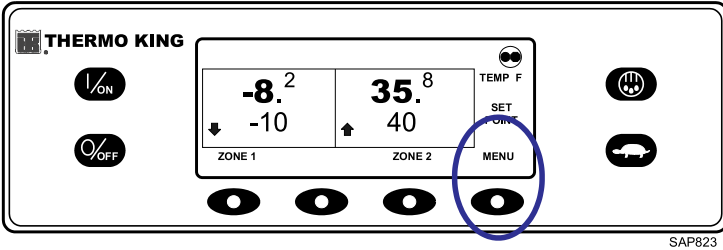
The following features are available in Sleep Mode:

- **Program Wakeup Time:** This feature allows a wakeup time to be specified. When the selected time is reached the unit will start and resume normal operation. If a Wakeup Time is selected, the following features are available:
  - **Day to Wake Up:** This feature allows the day of the week the unit is to wake up to be specified.
  - **Hour to Wake Up:** This feature allows the hour the unit is to wake up to be specified.
  - **Minute to Wake Up:** This feature allows the minute the unit is to wake up to be specified.
  - **Run Pretrip on Wakeup:** This feature allows a Pretrip Test to be automatically run when the unit wakes up.

Mode changes are made using the Mode Menu. From the Standard Display, press the MENU key.

**Operating Instructions for Premium HMI Control Panel**

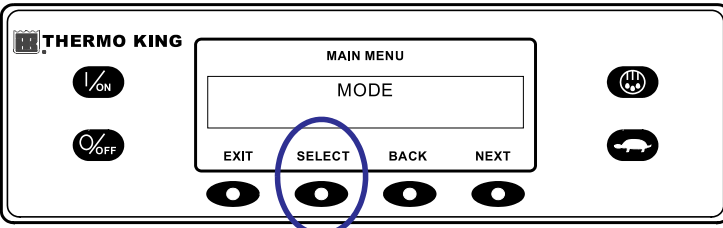
**Figure 77. Menu Key**



SAP823

The Language Menu or Alarm Menu will appear. Press the NEXT key as required to show the Mode Menu. When the Mode Menu is shown, press the SELECT key.

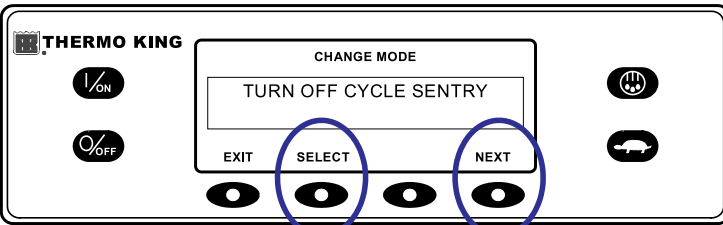
**Figure 78. Select Key**



SAP477

The first mode change screen will appear. To choose that function, press the SELECT key. To Scroll through the Mode Menu, press the NEXT key.

**Figure 79. Select and Next Keys**



SAP478

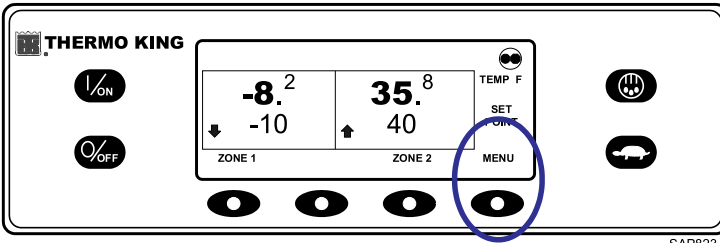
**Selecting CYCLE-SENTRY or Continuous Mode****⚠ CAUTION****Risk of Injury!**

The engine may start automatically any time the unit is turned on.

**⚠ CAUTION****Risk of Injury!**

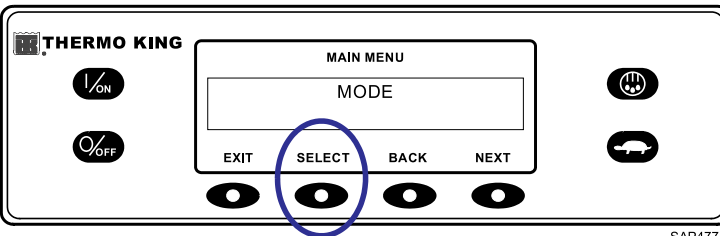
If the unit is in CYCLE-SENTRY null and the mode is switched to Continuous Mode, the unit will start automatically.

When CYCLE-SENTRY mode is selected, the unit will start and stop automatically to maintain setpoint, keep the engine warm, and the battery charged. When Continuous Mode is selected, the unit will start automatically and run continuously to maintain setpoint and provide constant airflow. From the Standard Display, press the MENU key.

**Figure 80. Menu Key**

SAP823

The Language Menu or Alarm Menu will appear. Press the NEXT key as required to display the Mode Menu. When the Mode Menu is shown press the SELECT key.

**Figure 81. Select Key**

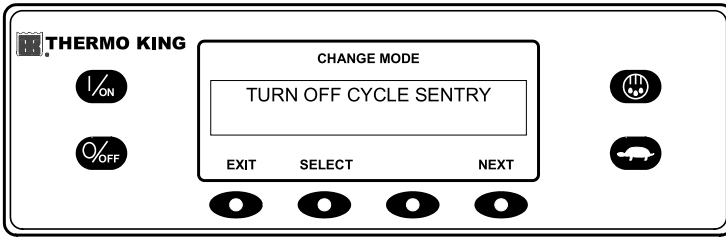
SAP477



## Operating Instructions for Premium HMI Control Panel

The Turn Off/Turn On CYCLE-SENTRY screen will appear. In the display shown (Figure 82, p. 73), the unit is operating in CYCLE-SENTRY mode. Turning CYCLE-SENTRY mode off will result in the unit running in Continuous mode.

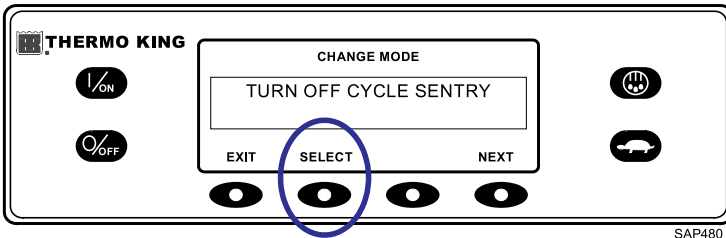
**Figure 82. Turn Off/Turn On CYCLE-SENTRY Screen**



SAP479

Pressing the Select key will change the mode from CYCLE-SENTRY to Continuous.

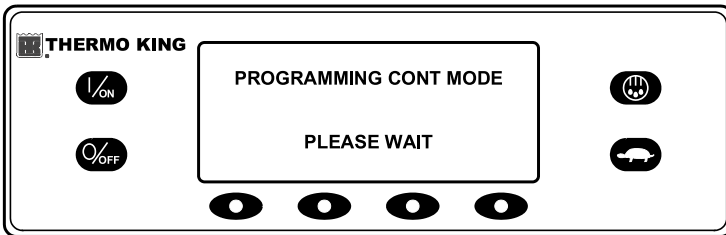
**Figure 83. Select Key**



SAP480

The display will confirm the change as shown (Figure 84, p. 73).

**Figure 84. Programming Screen**



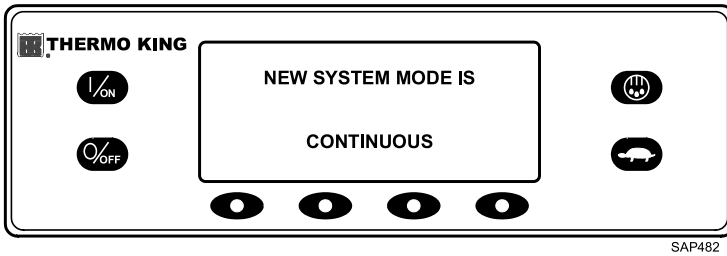
SAP481

## Operating Instructions for Premium HMI Control Panel

---

The new mode is then confirmed for 10 seconds.

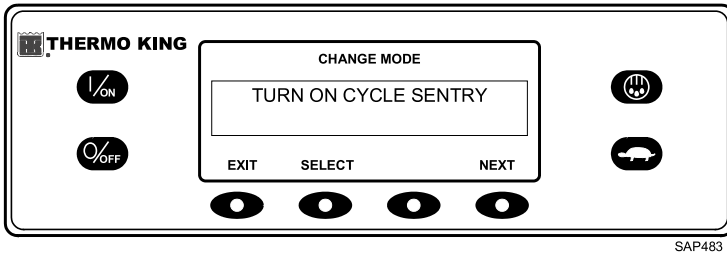
**Figure 85. Mode Confirmed**



The display then returns to the Mode Menu. In the example shown (Figure 86, p. 74), the unit is currently running in Continuous Mode. Pressing the Select key again allows the operator to change back to CYCLE-SENTRY mode operation.

**Important:** *If the unit is in CYCLE-SENTRY null and the mode is switched to Continuous Mode, the unit will start automatically.*

**Figure 86. Mode Menu**

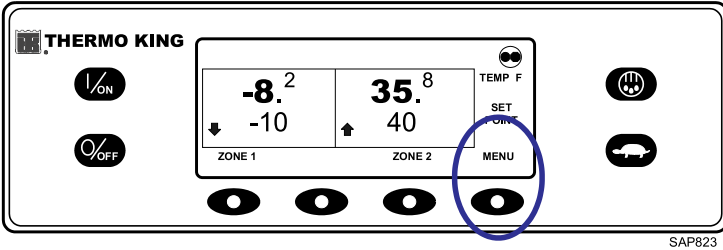


## Selecting Temperature Display Units

This feature, if enabled in Guarded Access, allows the operator to set temperature units to be display in either Fahrenheit or Celsius. From the Standard Display, press the MENU key.

# Operating Instructions for Premium HMI Control Panel

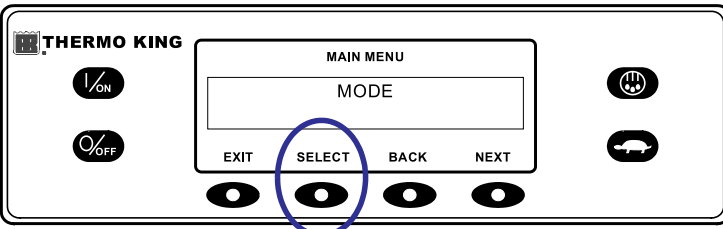
**Figure 87. Menu Key**



SAP823

The Language Menu or Alarm Menu will appear. Press the NEXT key as required to display the Mode Menu. When the Mode Menu is shown, press the SELECT key.

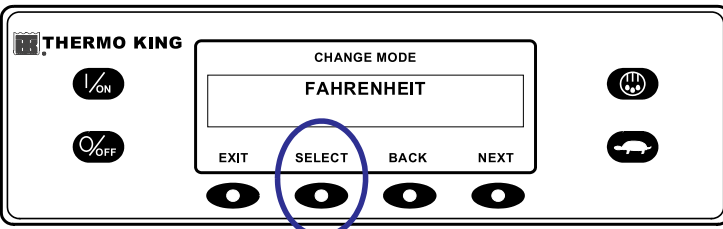
**Figure 88. Select Key**



SAP477

The TURN OFF/TURN ON Cycle Sentry screen will appear. Press the NEXT key as required to display the Temperature Display Screen. This feature must be enabled or it will not appear in the Mode Menu.

**Figure 89. Select Key**

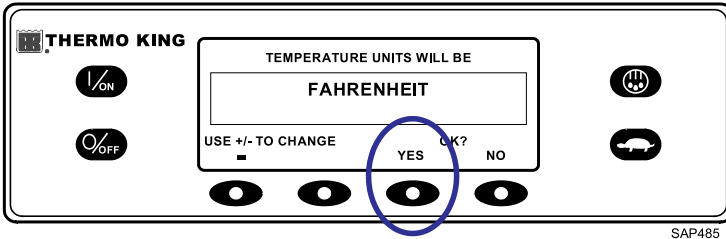


SAP484

## Operating Instructions for Premium HMI Control Panel

The Temperature Display screen will appear. Use the + and - soft keys to chose either FAHREHEIT or CELSIUS. When the desired temperature units are shown, press the YES soft key to select.

**Figure 90. Temperature Display Screen**

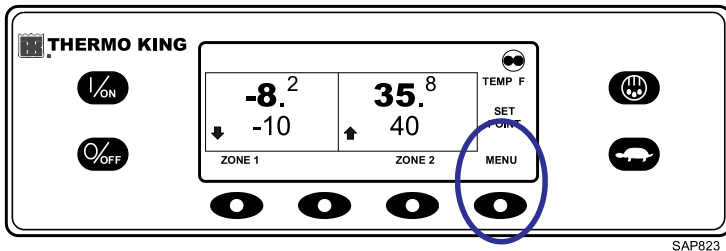


After the YES soft key has been pressed, the display will briefly show PROGRAMMING TEMPERATURE UNITS – PLEASE WAIT. The display confirms the new setting for two seconds and then returns to the Standard Display.

## Keypad Lockout

This feature, if enabled in Guarded Access, allows the keypad to be locked to prevent unauthorized use or tampering. If the keypad is locked, only the ON and OFF keys are functional. Access to all other keys is denied. Keypad Lockout is turned on by choosing the Main Menu and then selecting Keypad Lockout from within the Mode submenu. From the Standard Display, press the MENU key.

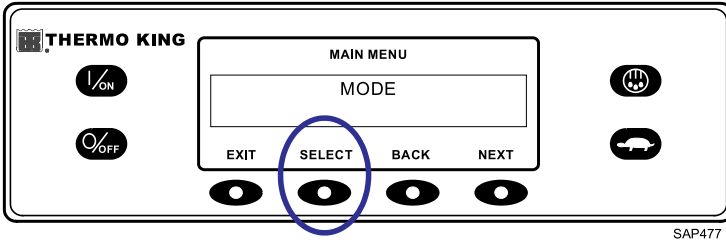
**Figure 91. Menu Key**



The Language Menu or Alarm Menu will appear. Press the NEXT key as required to display the Mode Menu. When the Mode Menu is shown press the SELECT key.

# Operating Instructions for Premium HMI Control Panel

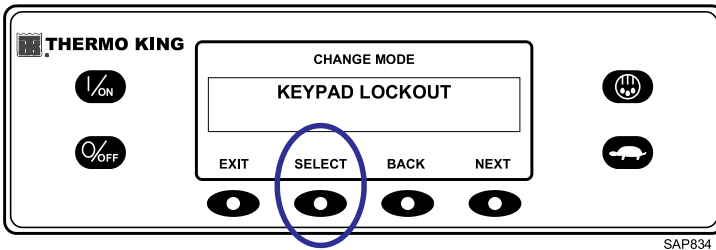
**Figure 92. Select Key**



The TURN OFF/TURN ON CYCLE SENTRY screen will appear. Press the NEXT key as required to display the Keypad Lockout Screen.

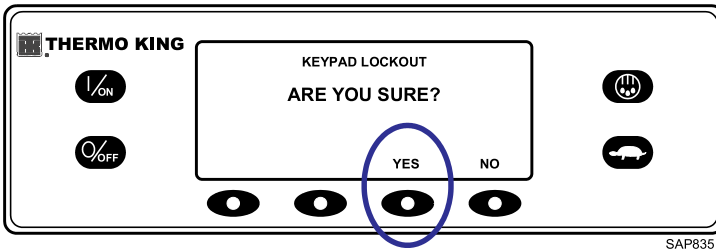
**Note:** This feature must be enabled or it will not appear in the Mode Menu.

**Figure 93. Keypad Lockout**



The Keypad Lockout Confirmation screen will appear. To enter Keypad Lockout Mode press the YES soft key to confirm the choice.

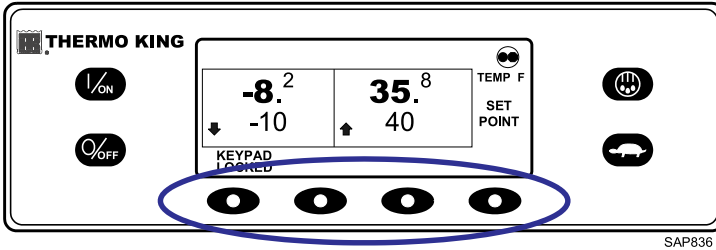
**Figure 94. Confirmation Screen**



## Operating Instructions for Premium HMI Control Panel

After the YES soft key has been pressed, the display will briefly show KEYPAD LOCKED. The display confirms the setting for two seconds and then returns to the Locked Standard Display.

**Figure 95. Locked Standard Display**



To exit Keypad Lockout Mode press and hold any of the soft keys for five seconds. Keypad Lockout Mode will be turned off and the Standard Display will appear.

### Selecting Sleep Mode

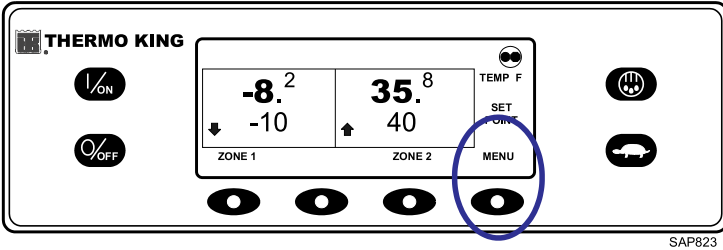
Normal CYCLE-SENTRY mode starts and stops the unit as required to maintain the desired setpoint temperature, maintain the unit battery in a charged condition, and keep the engine warm in cold ambient conditions. Sleep Mode does not consider setpoint or maintain cargo temperatures - it only keeps the engine warm and the unit battery charged. This is useful in extremely cold weather or when the unit is to be out of service for an extended time. Sleep Mode operates in both Diesel and Electric. In Diesel, the unit will start and stop as required to maintain engine temperature and battery charge. In Electric, the unit starts and stops as necessary to maintain battery charge only.

When Sleep Mode is entered, the operator can program an automatic Wake-up Time up to a week away. Using this feature, the unit will automatically restart and run normally at the determined time. If a Wake-up Time is programmed, the operator can also program an automatic Pretrip Test when the unit restarts.

Sleep Mode is turned On and Off using the Mode Menu. From the Standard Display, press the MENU key.

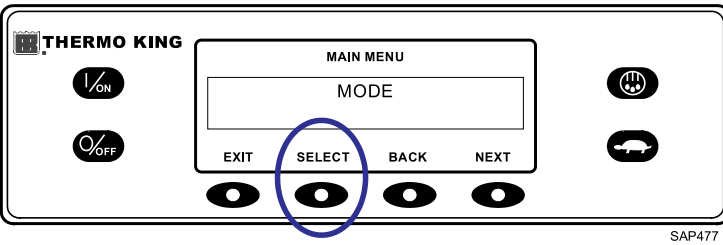
**Operating Instructions for Premium HMI Control Panel**

**Figure 96. Menu Key**



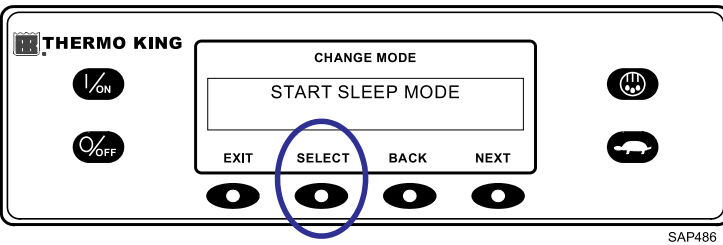
The Language Menu or Alarm Menu will appear. Press the NEXT key as required to show the Mode Menu. When the Mode Menu is shown, press the SELECT key.

**Figure 97. Select Key**

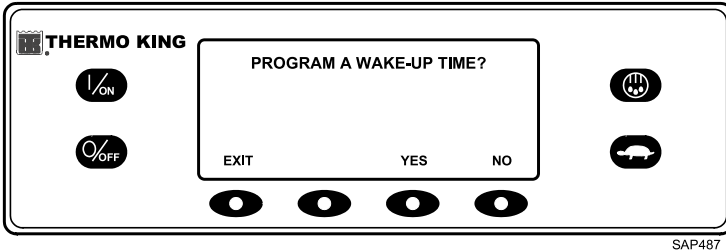


Press the Next key as required to display the Sleep Mode prompt. Press the Select key to choose the Sleep Mode menu.

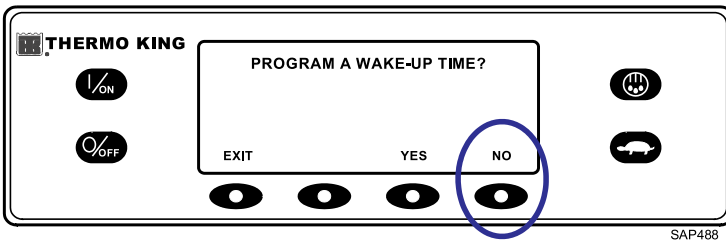
**Figure 98. Select Key**



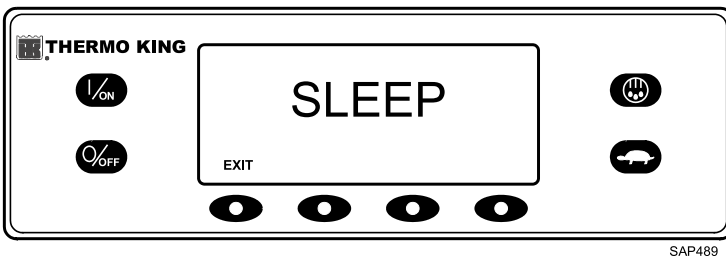
The screen shown (Figure 99, p. 80) will appear.

**Figure 99. Start of Sleep Mode Menu**

The operator can now choose a Sleep Mode Wake-up Time or simply enter Sleep Mode immediately. If NO is pressed, the unit will immediately enter Sleep Mode.

**Figure 100. Select No to Enter Sleep Mode**

The display will show SLEEP and the unit will start and stop as required to keep the engine warm and/or the battery charged. To exit Sleep Mode, press the EXIT key or turn the unit off and back on. The unit will resume normal operation and control to setpoint.

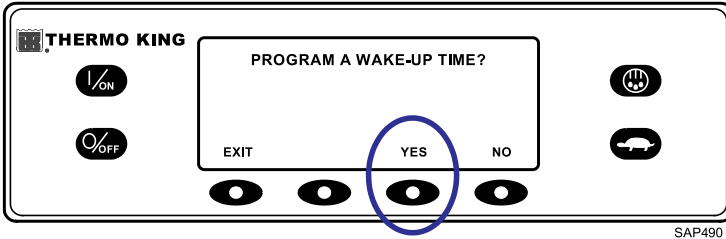
**Figure 101. Sleep Mode Display**



## Operating Instructions for Premium HMI Control Panel

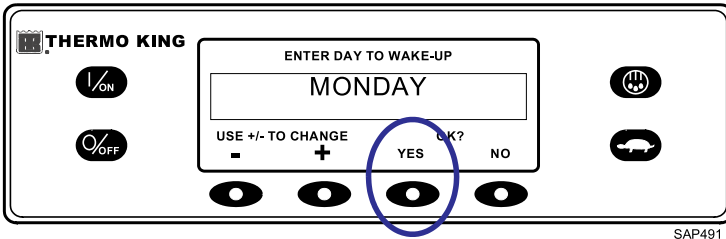
To enter a Wake-up Time, verify the unit clock is set properly. Press the YES key at the Sleep Mode Menu.

**Figure 102. Yes Key**



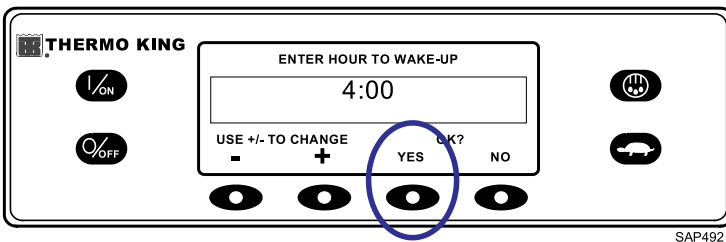
The display will prompt the operator for the DAY the unit is to restart in normal operation. In the example shown (Figure 103, p. 81), Monday has been chosen. Press the YES key to confirm the DAY.

**Figure 103. Confirm Day**



The display will now prompt the operator for the HOUR the unit is to restart in normal operation. In the example shown (Figure 104, p. 81), 4:00 am has been chosen. Press the YES key to confirm the HOUR (24 hour "military time" is used).

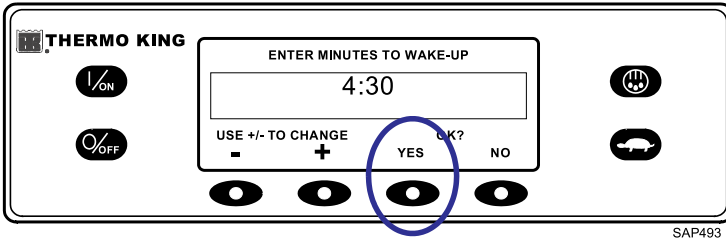
**Figure 104. Confirm Hour**



## Operating Instructions for Premium HMI Control Panel

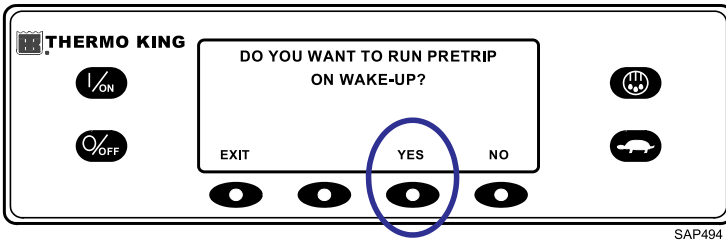
The display will now prompt the operator for the MINUTE the unit is to restart in normal operation. In the example shown (Figure 105, p. 82), 4:30 am has been chosen. Press the YES key to confirm the MINUTE.

**Figure 105. Confirm Minute**



The display will now prompt for a Pretrip Test on Wake-up. Press the YES key to perform a Pretrip Test on Wake-up. If the No key is pressed, the unit will resume normal operation on Wake-up.

**Figure 106. Press Yes Key for Pretrip Test**

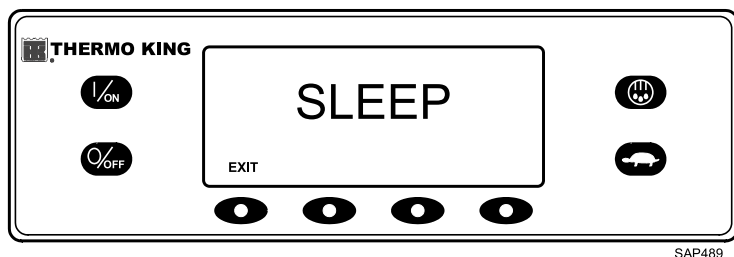


The display will show SLEEP and the unit will start and stop as required to keep the engine warm and/or the battery charged.

**Note:** *The unit may start when sleep is enabled to bring battery charge level and engine temperature up to minimum level. It will shut down and then maintain minimum levels.*

## Operating Instructions for Premium HMI Control Panel

**Figure 107. Sleep Mode**



The unit will restart at the programmed time (in this example 4:30 am) and perform a Pretrip Test (if selected). After the Pretrip Test is complete, the test results will be displayed and the unit will resume normal operation and control to setpoint.

To exit Sleep Mode before the selected Wake-up time, press the EXIT key or turn the unit off and back on. The unit will resume normal operation and control to setpoint.

### Pretrip

A Pretrip Test verifies unit operation. This display allows a Pretrip Test to be selected and initiated by the operator. If the Pretrip Test is entered with the unit shut down, a Full Pretrip Test with device amp checks will be performed. If the Pretrip Test is entered with the unit running in either diesel or electric mode, a Running Pretrip Test is performed, but the device amps checks are not performed. Test results are reported as PASS, CHECK, or FAIL when the Pretrip Test is completed. If an alarm occurs during a Pretrip Test, the alarm code will be displayed as Pretrip Alarm XX, where XX is the alarm code.

### Pretrip Test Conditions

- Current unit settings are saved and restored at the end of the Pretrip Test or if the unit is turned off and back on.
- Pretrip Test can be run in either Diesel or Electric Mode.
- The unit will auto switch from Diesel to Electric Mode or from Electric to Diesel Mode during a Pretrip Test if these features are enabled and the auto-switch conditions occur.

### Conditions where Pretrip Tests are Not Allowed

- If any Shutdown Alarms are present. Pretrip tests are allowed with some Check and Log Alarms.

## Operating Instructions for Premium HMI Control Panel

---

- If the unit is in Sleep Mode.
- If the unit is in Service Test Mode, Interface Board Test Mode, or Evacuation Mode.

### Pretrip Test Sequence

Pretrip tests proceed in the order shown below. A Full Pretrip Test includes all tests. A Running Pretrip Test is started with the engine or electric motor running and does not include the Amp Checks or Engine Start Check.

- Amp Checks - Each electrical control component is energized and the current drawn is confirmed as within specification.
- Engine Start - The engine will start automatically.
- Defrost - If the coil temperature is below 45°F (7°C), a defrost cycle is initiated.
- RPM Check - The engine RPM in high and low speed is checked during the Cool Check.
- Cool Check - The ability of the unit to cool in low speed is checked.
- Heat Check - The ability of the unit to heat in low speed is checked.
- Report Test Results - The test results are reported as PASS, CHECK, or FAIL when the Pretrip Test is completed. If test results are CHECK or FAIL, alarm codes will exist to direct the technician to the source of the problem.

### Pretrip Test Considerations

When performing a Pretrip Test, the following issues should be considered:

- If running a Pretrip Test on a truck loaded with dry cargo, verify proper airflow can occur around the load. If the load restricts airflow, false test results may occur. Also, SR-3 units have high refrigeration capacity which results in rapid temperature changes. Sensitive dry cargo may be damaged as a result.
- If running a Pretrip Test on a truck that has just been washed down, the extremely high humidity inside the truck may result in false test results.
- If running a Pretrip Test on a truck loaded with sensitive cargo, monitor the load temperature during the test as normal temperature control is suspended during a Pretrip Test.
- Always perform Pretrip Tests with the truck cargo doors closed to prevent false test failures.

## Operating Instructions for Premium HMI Control Panel

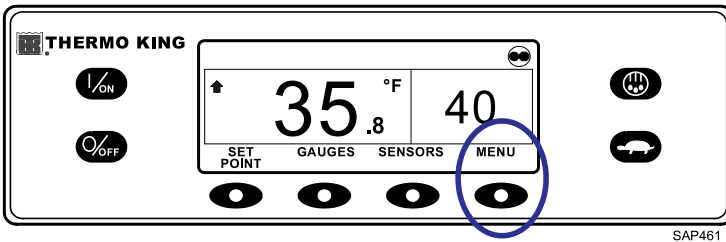
### Performing a Pretrip Test

If a Pretrip Test is initiated with the engine shut down, a Full Pretrip Test will be performed. If a Pretrip Test is initiated with the engine or electric motor running, a Running Pretrip Test is performed.

- Before initiating a Pretrip Test, clear all alarm codes.
- To stop a Pretrip Test at any time, turn the unit off. Alarm Code 28 Pretrip Abort will be set. Other alarms may also be set depending upon test in progress when the test was terminated.

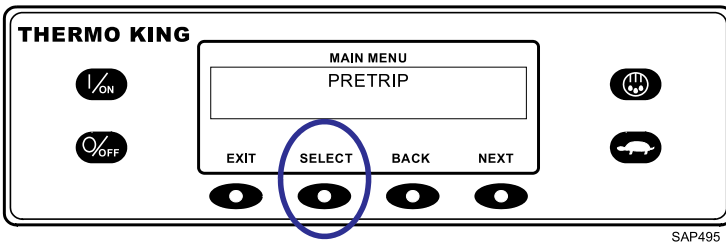
Pretrip Tests are initiated using the Pretrip Menu. From the Standard Display, press the MENU key.

**Figure 108. Menu Key**

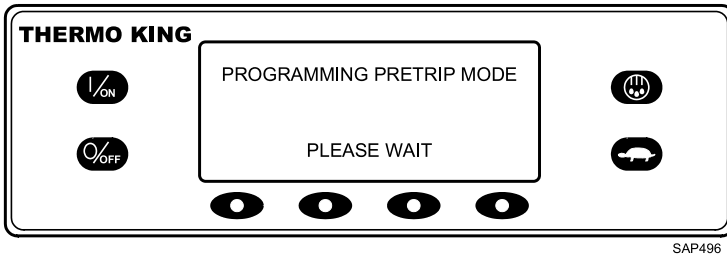


The Language Menu or Alarm Menu will appear. Press the NEXT key as required to display the Pretrip Menu. When the Pretrip Menu is shown, press the SELECT key.

**Figure 109. Select Key**



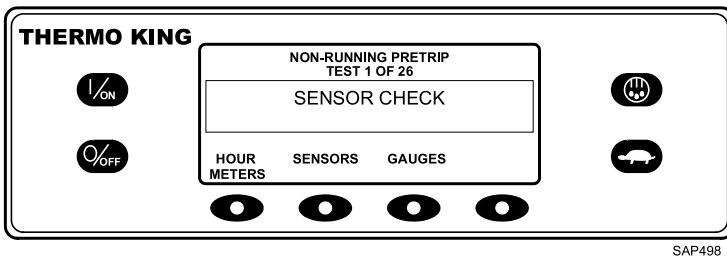
If the unit is not running, a Full Pretrip Test will be initiated. If the unit is running in either diesel or electric mode, a Running Pretrip will be performed.

**Figure 110. Running Pretrip**

If all alarms were not cleared, a prompt appears as shown (Figure 111, p. 86). Exit the Pretrip Test, clear all alarms, and restart the Pretrip Test.

**Figure 111. No Pretrip Prompt**

If no alarms are present, the Pretrip Test display appears.

**Figure 112. Pretrip Test Display**

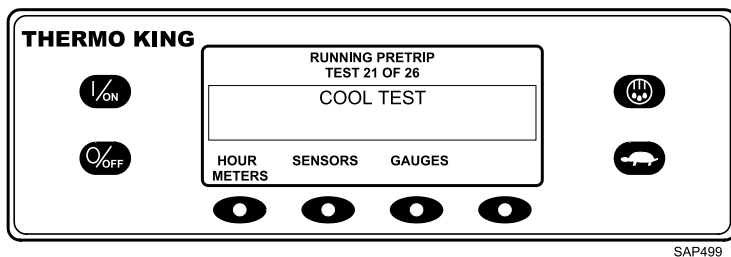
- The top line of the display indicates the unit is performing the non-running portion of the Pretrip Test.

## Operating Instructions for Premium HMI Control Panel

- The second line measures test progress. The number of tests completed of the total number of tests to be performed is shown. In the example (Figure 112, p. 86), the unit is performing Test 1 of 26, Sensor Check.
- The soft keys may be used during the Pretrip Test to select the Hourmeter, Gauge, or Sensor Menus.
- To stop a Pretrip Test at any time, turn the unit off. This will generate Alarm Code 28 Pretrip Abort. Other alarm codes may also be generated. This is normal when the Pretrip Test is halted before completion.

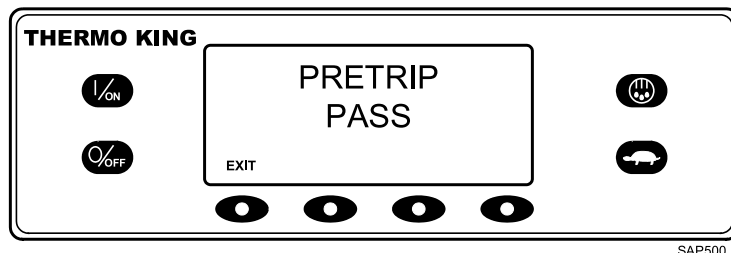
When the non-running tests are complete, the unit will start automatically and continue with the Running Pretrip Test. In the example shown (Figure 113, p. 87), the unit is in the Running Pretrip and is performing Test 21 of 26, Cool Test.

**Figure 113. Performing Cool Test**



When all tests are complete, the results are reported as PASS, CHECK, or FAIL. If the results are CHECK or FAIL, the accompanying alarm codes will direct the technician to the cause of the problem. If the Pretrip Test results are CHECK or FAIL, the problem should be diagnosed and corrected before the unit is released for service.

**Figure 114. Pass, Check, or Fail**



## Diesel/Electric Menu

The Diesel Mode/Electric Standby menu allows the operator to manually select diesel or electric mode operation. The unit can also be programmed to automatically select electric mode operation when standby power is available and to automatically select diesel mode operation if standby power fails or is removed. Refer to [“Switching from Diesel to Electric,” p. 40](#) and [“Switching from Electric to Diesel,” p. 41](#) for details.

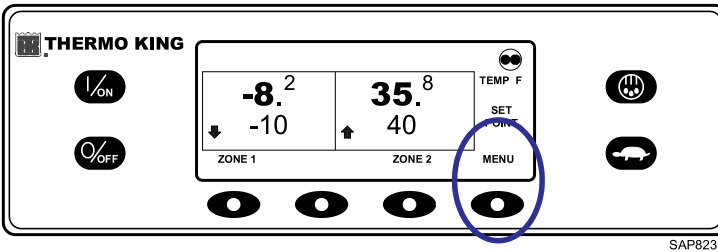
**Note:** *If the unit is programmed to switch automatically from diesel to electric and electric to diesel the normal screens do not appear.*

## Adjust Brightness Menu

The brightness of the HMI Controller display can be adjusted to allow for changing ambient light conditions. The choices available to the operator are HIGH, MEDIUM, LOW, and OFF. OFF actually results in a very dim screen suitable for low light conditions.

Display brightness is adjusted using the Adjust Brightness Menu. From the Standard Display, press the MENU key.

**Figure 115. Menu Key**

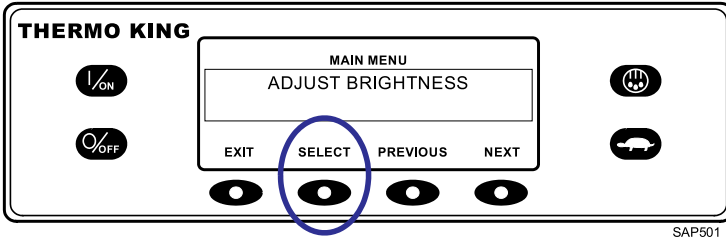


The Language Menu or Alarm Menu will appear. Press the NEXT key as required to display the Adjust Brightness Menu. When the Adjust Brightness Menu is shown, press the SELECT key.



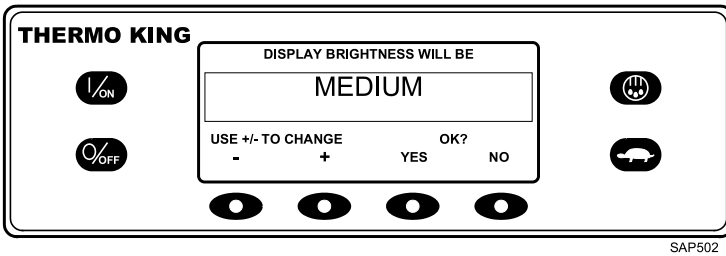
# Operating Instructions for Premium HMI Control Panel

**Figure 116. Select Key**



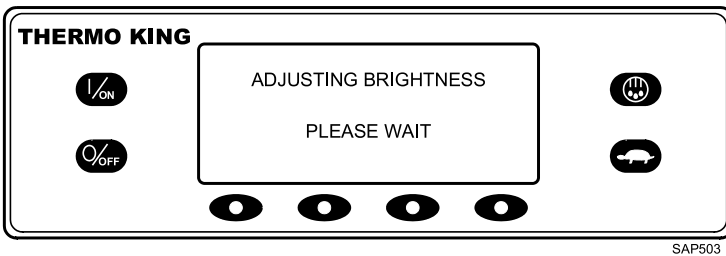
The Display Brightness menu will appear as shown (Figure 117, p. 89). Press the + or - keys to select the desired display brightness. When the desired brightness is shown, press the YES key to confirm the choice.

**Figure 117. + and - Keys**



The display will briefly show ADJUSTING BRIGHTNESS - PLEASE WAIT. The display brightness is changed to the new setting. To return to the Main Menu press the EXIT soft key. To return to the Standard Display press the EXIT soft key again.

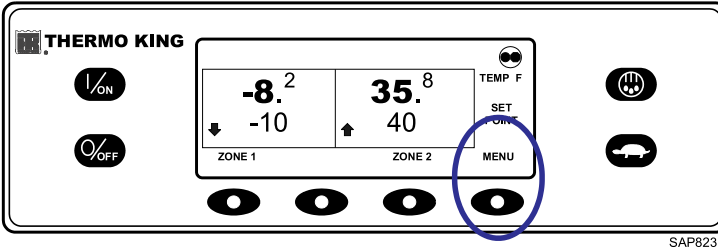
**Figure 118. Adjusting Brightness**



## Time Menu

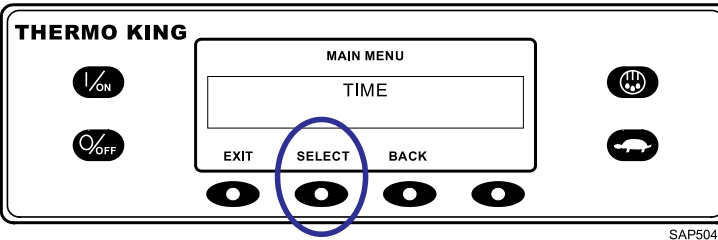
The system time and date is viewed using the Main Menu. Time and Date cannot be changed from the Main Menu. From the Standard Display, press the MENU key.

**Figure 119. Menu Key**



The Language Menu or Alarm Menu will appear. Press the NEXT key as required to display the Time Menu. When the Time Menu is shown, press the SELECT key.

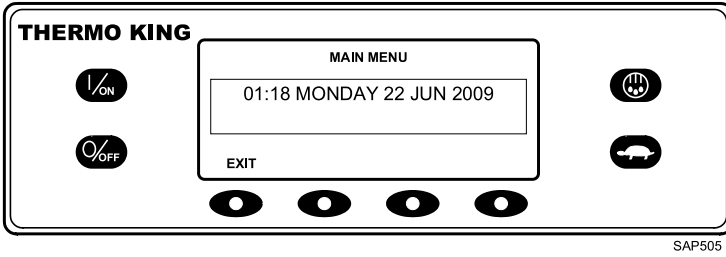
**Figure 120. Select Key**



The current time and date will appear. To return to the Main Menu press the EXIT soft key. To return to the Standard Display press the EXIT soft key again.

# Operating Instructions for Premium HMI Control Panel

**Figure 121. Current Time and Date**



# Loading and Enroute Inspections

**Important:** Make sure cargo is pre-cooled to the proper temperature before loading. The Thermo King unit is designed to maintain temperature, not cool an above-temperature load.

1.	Inspect unit condenser grille openings to ensure they are free of debris.
2.	Inspect evaporator defrost drains to ensure they are not plugged or kinked.
3.	Confirm there is sufficient fuel in tank to operate unit for time required for deliveries.
4.	Maintain a minimum of 1219 mm (48 in.) between evaporator air outlets and wall or bulkhead.
5.	Inspect cargo box compartment inside and out for: <ul style="list-style-type: none"> <li>Inspect condition of door seals. They must seal tightly with no air leakage.</li> <li>Damaged walls, missing insulation or blocked floor channels.</li> <li>Inspect bulkheads (if applicable) for a air tight fit at ceiling, walls, and floor.</li> </ul>
6.	Using the HMI Controller, turn the unit on to pre-cool cargo compartment: <ul style="list-style-type: none"> <li>Adjust setpoint to desired cargo temperature and allow unit to run a minimum of 30 to 60 minutes (longer if possible) before loading cargo.</li> </ul>
<p><b>Important:</b> As product is being loaded, make sure evaporator air inlets and outlets are not blocked. Maximum air circulation is necessary to properly maintain the temperature of the entire load.</p>	

## Inspecting the Load

Never assume that the product has been loaded properly. Watch for and perform the following tasks. It takes only a few minutes and could save you or your employer considerable time and money later on.

1. Turn the unit off before opening the cargo box doors to maintain efficient operation. Opening the doors while the unit is running allows warm air to enter the cargo box.

**Note:** The unit can be run with the doors open if the truck is backed into a refrigerated warehouse with tight loading dock door seals.

2. Perform a final check of the load temperature. If the load is too hot or too cold, make a final notation on the manifest.
3. While inspecting to see that the cargo is loaded properly, make sure the evaporator air inlets and outlets are not blocked.
4. Close or supervise the closing of the cargo compartment doors. Make

sure they are securely locked.

5. Check to make sure the unit setpoint is set at the desired temperature as listed on the manifest.
6. If the unit was stopped, restart using the appropriate starting procedure outlined in this manual.
7. Repeat the after-start inspection.
8. Defrost the unit 30 minutes after loading by starting a manual defrost cycle.

## Enroute Inspections

**Note:** *Enroute inspections are recommended every four hours for the prevention of damage to the cargo.*

1. Note the setpoint to make certain no one has altered the setting since picking up the load.
2. Note the return air temperature reading. It should be within the desired temperature range. If the return air temperature reading is not within the desired temperature range, it indicates one of the following:
  - a. The unit has not had sufficient time to pull down the temperature. Refer to log, if possible, for history of load (for example, above temperature load, properly pre-cooled cargo compartment, length of time on road).
  - b. The unit is in defrost or has just completed defrost.

**Note:** *You can cancel defrost by turning the unit off, then restarting the unit.*

- c. The evaporator is plugged with frost. Initiate a manual defrost cycle. The defrost cycle will be automatically terminated.
- d. Improper air circulation within the cargo compartment. Inspect the cargo compartment (if possible) to determine if the evaporator fans are working and properly circulating the air. Poor air circulation can be due to improper loading of the cargo or shifting of the load, or the fan belt slipping
- e. The unit did not start automatically. If the unit cranked without starting, determine and correct the cause for not starting.
- f. The unit may have a low refrigerant charge. If liquid is not showing in the unit receiver tank sight glass, the refrigerant charge may be low. Adding refrigerant or repairing the refrigeration system requires a competent mechanic. Refer such problems to the nearest Thermo

## Loading and Enroute Inspections

---

King dealer or authorized Service Center, or call the Thermo King Cold Line telephone number shown on the inside back cover of this manual for referral.

**Note:** *If the temperature in the compartment is not within the desired temperature range, repeat the Enroute Inspection every 30 minutes until the compartment temperature comes within the desired temperature range.*

**Important:** *Stop the unit if the compartment temperature remains outside the desired temperature range from the setpoint on two consecutive 30 minute inspections. Contact the nearest Thermo King Service Center or your company office immediately. Take all necessary steps to protect and maintain proper load temperature.*

3. Initiate a Manual Defrost cycle after each Enroute Inspection.

# Specifications

## Engine Specifications

Engine	T-1090 SPECTRUM: TK380F (Tier 4)
Fuel Type	Ultra low sulfur diesel (ULSD) fuel only [conforming to ASTM D975] No. 2 diesel fuel under normal conditions No. 1 diesel fuel is acceptable cold weather fuel
Oil Capacity	T-1090 SPECTRUM: 12.0 quarts (11.4 liters/litres) crankcase and oil filter  T-1090 SPECTRUM: 13.0 quarts (12.3 liters/litres) w/Bypass Oil Filter - Fill to full mark on dipstick
Oil Type	API Classification CJ-4 or CK-4 ACEA Rating E6  <b>Note:</b> API Classification FA-4 oils are not approved for use and should not be used.
Oil Viscosity	14 F to 122 F (-10 C to 50 C): SAE 15W-40 (Synthetic) 5 to 104 F (-15 to 40 C): SAE 15W-40 5 to 104 F (-15 to 40 C): SAE 10W-30 (Synthetic or Synthetic Blend) -13 to 104 F (-25 to 40 C): SAE 10W-40 -13 to 86 F (-25 to 30 C): SAE 10W-30 -22 to 122 F (-30 to 50 C): SAE 5W-40 (Synthetic) Below -22 F (-30 C): SAE 0W-30 (Synthetic)
Cooling System Capacity	T-1090 SPECTRUM: 8.36 quarts (7.91 liters/litres)
Engine Coolant Type	Factory filled with Chevron Delo® XLC extended life coolant (ELC). 55/45 glycol/water concentration Freeze protection of -40°F/ -40°C  <b>Compatible coolants:</b> Chevron Delo® XLC Havoline Delo® XLC (Europe) Caltex Delo® XLC (Asia) OR Meets the performance requirements of both ASTM D6210 and ASTM D3306 OAT extended life coolant, nitrite free

## Specifications

<p><b>Important:</b> Only OAT extended life coolants (Chevron Delo® XLC or equivalent) should be added to Thermo King systems. Conventional coolants should not be used (Typically identified by green or blue-green color). If a conventional coolant is combined with the Thermo King factory fill up to 25% by volume, the coolant must be changed at the next service opportunity. Above 25%, the coolant must be changed immediately. Conventional coolants dilute/interact with the additive packages of extended life coolant which significantly reduces the service life of the coolant.</p>	
Engine Thermostat	160 F (71 C)
Coolant Expansion Tank Cap Pressure	10 psig (69 kPa)

## Refrigeration System

Contact your Thermo King dealer for refrigeration service or maintenance.

## Electrical Control System Specifications

Control System Voltage	12.5 Vdc
Battery Charging System	12 volt, 37 amp, brush type, Thermo King Alternator
Voltage Regulator Setting	13.4 to 14.5 volts

## Fuses

Fuse	Size	Function
F2	15A	Power to On/Off Switch
F3	40A	Fuel Sol Pull-In/Starter Circuit
F4	None	No Fuse
F5	40A	Preheat Circuit
F6	15A	Damper and High Speed Circuits
F7	2A	8XP Circuit - Controller On Feedback to HMI
F8	5A	2A Power to CAN Connector J12
F9	5A	2A Power to CAN Connector J14



Fuse	Size	Function
F10	10A	8X Power (Install fuse in right position)
F11	None	No Fuse
F12	5A	2A Power to CAN Connector J13
F13	2A	8FC Circuit (Remote Status Light/Optional Power)
F20	2A	Alternator Sense
F21	60A	Main Fuse (2 Circuit)
F25	7.5A	HPCO Switch Circuit
F26	5A	Power to CAN Connector J98

**F10** When fuse F10 is installed in the right position the On/Off keys on the HMI turn the unit on and off. When fuse F10 is installed in the left position the unit will start and run without the HMI controller.

## Electric Standby Specifications (SmartPower™ Model 50 Units)

### Electric Motor and Overload Relay

#### T-1090 and T-1090 SPECTRUM

Voltage/ Phase/ Frequency	Horse- power	Kilowatts	RPM	Full Load (amps)	Overload Relay Setting (amps)
230/3/50	10.0	7.5	1460	25.3	38
200-230/3/60	12.0	8.9	1750	28.8	38
400/3/50	10.0	7.5	1460	13.90	19
460/3/60	12.0	8.9	1750	14.4	19

## Specifications

---

### Standby Power Requirements

<b>Standby Power cord to remote receptacle</b>	<b>Power plug rating</b>	<b>Power Supply circuit breaker</b>	<b>Plug configuration</b>	<b>Plug type</b>
12/9HP Motor <b>(T-1090 SPECTRUM)</b>	230 V 50A	50 A	CS8364	Twistlock

# Unit Maintenance

A regular inspection and maintenance program will help to keep your unit in top operating condition. While pre-trip inspections can be performed by the operator (e.g., checking oil and coolant levels), all major and minor service requirements should be handled by a Thermo King dealer for four very important reasons:

- They are equipped with the factory recommended tools to perform all service functions
- They have factory trained and certified technicians
- They have genuine Thermo King replacement parts
- The warranty on your new unit is valid only when the repair and replacement of component parts is performed by an authorized Thermo King dealer

After the first week of operation:

- Retighten unit mounting bolts
- Check belt tension
- Check coolant level
- Check engine oil level
- Check refrigerant level
- Check refrigerant oil level

The following general maintenance inspection schedule is provided to assist in monitoring that maintenance.

## Maintenance Inspection Schedule

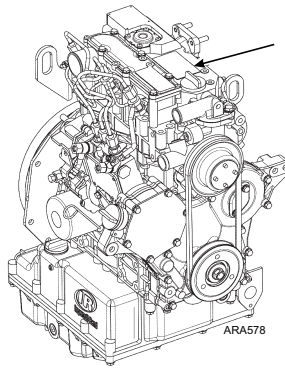
### Remote Evaporators

Pretrip	1,200 Hours	Annual/ 3,000 Hours	Inspect/Service These Items	Completed
<b>Electrical</b>				
	•	•	Inspect wire harness for damaged wires or connections.	
		•	Inspect/replace DC fan motors.	
<b>Structural</b>				
•	•	•	Visually inspect unit for fluid leaks.	
•	•		Visually inspect unit for damaged, loose or broken parts.	
	•	•	Clean entire unit including evaporator coils and defrost drains.	
		•	Check all mounting bolts, brackets, lines, hoses, etc.	

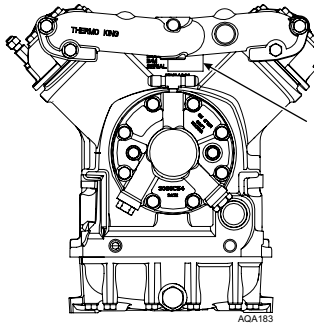
# Serial Number Locations

The serial number of your unit, the engine, or the compressor may be required when contacting a Thermo Dealer or the Emergency Cold Line service. Record these numbers for quick access when needed.

**Figure 122. Engine Serial Number Location Shown (All Models)**

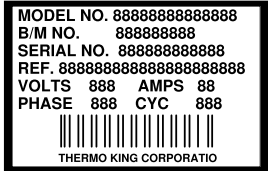
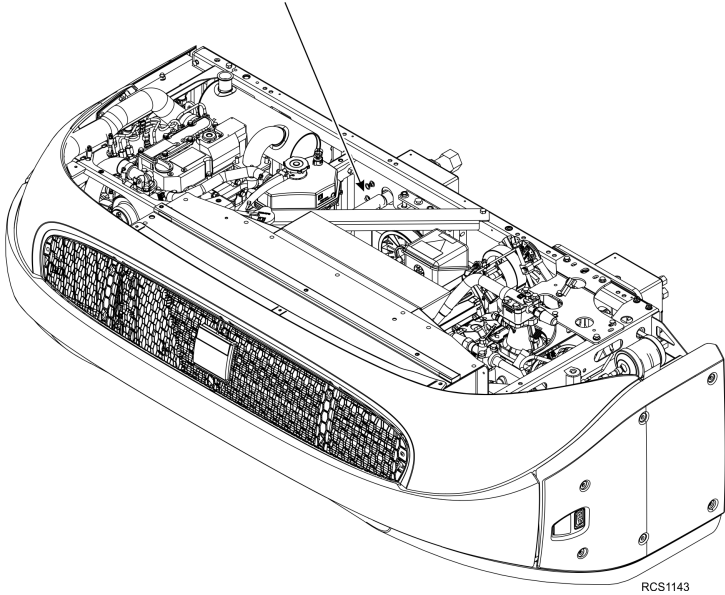


**Figure 123. X430P Compressor Serial Number Location Shown**



# Serial Number Locations

**Figure 124. Unit Serial Number Plate Located on Frame**



AGA011

**Figure 125. Serial Number Plate Location  
(S-3 shown, S-2 similar)**



1.	Serial nameplate on right end of evaporator frame behind cover
----	--

1.	Serial nameplate on right end of evaporator frame behind cover
----	--

# Emergency Cold Line



RCS358



# Unit Warranty

Please contact your nearest Thermo King dealer for terms of the Thermo King North American Self Powered Truck Unit Limited Warranty.

## EPA and ARB Supplemental Emissions Warranty Statement

Your Thermo King unit is covered by the diesel engine manufacturer's EPA and ARB Supplemental Emissions Warranty. Complete details of this emission warranty can be found at [www.thermoking.com](http://www.thermoking.com).





Thermo King – by Trane Technologies (NYSE: TT), a global climate innovator – is a worldwide leader in sustainable transport temperature control solutions. Thermo King has been providing transport temperature control solutions for a variety of applications, including trailers, truck bodies, buses, air, shipboard containers and railway cars since 1938. For more information, visit [www.thermoking.com](http://www.thermoking.com) or [www.tranetechnologies.com](http://www.tranetechnologies.com).

Thermo King has a policy of continuous product and product data improvements and reserves the right to change design and specifications without notice. We are committed to using environmentally conscious print practices.